

# Insignia

## Installation Guide

### RW109 Sauna

Should you require additional assistance with the installation of your product, please call 01908 317512 or email [customerservices@insigniashowers.com](mailto:customerservices@insigniashowers.com).





# INSTALLATION MANUAL

## RW109

### Sauna Series

#### 30 Day Technical Support:

Call **01908 317512** and request technical support for aiding your installation.

#### Replacements Parts: Inside of your warranty period visit:

<https://www.insigniashowers.com>, click support and make a warranty claim.

#### Spares/Replacements Parts: Outside of your warranty period visit

<https://www.insigniashowers.com/replacement-parts.html>

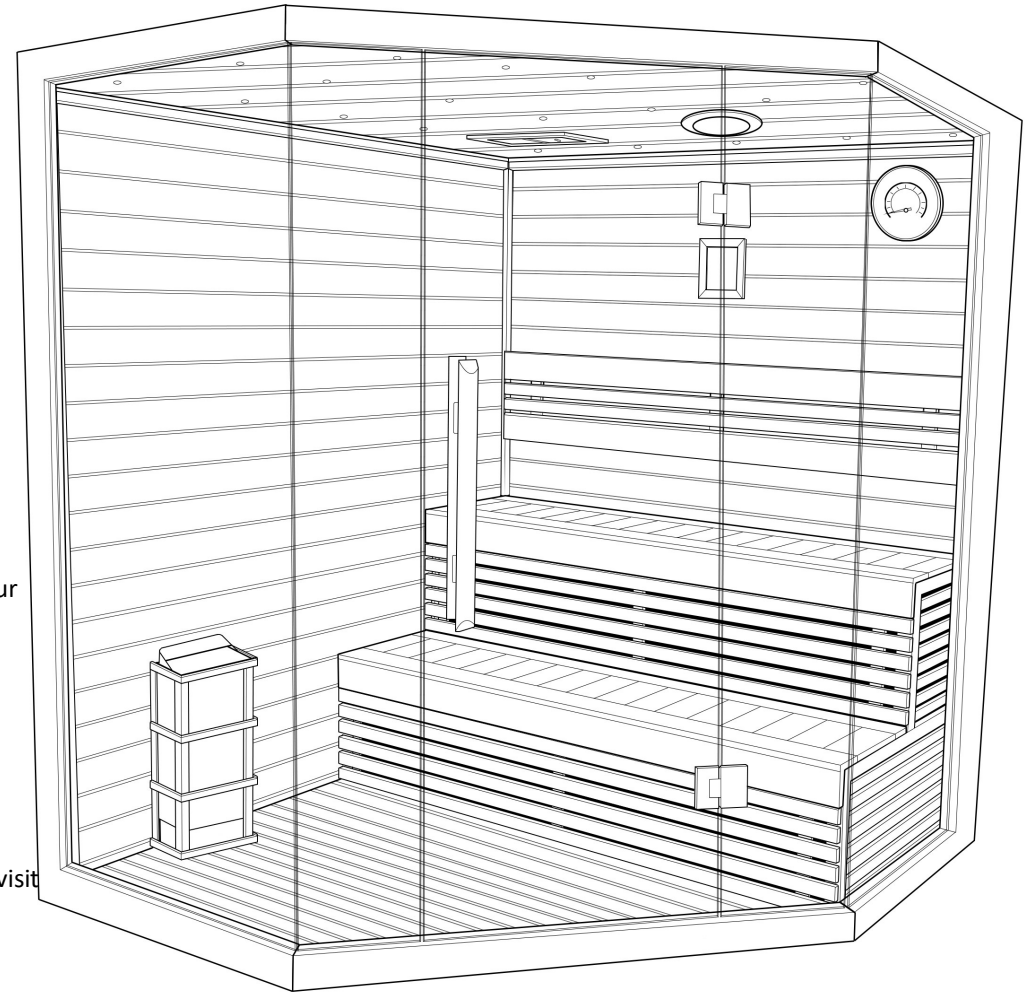

**ATTENTION INSTALLERS:**

These instructions must be left with the customer

**CHECK ALL CONTENTS BEFORE BUILD COMMENCES. NO RETURNS CAN BE MADE ONCE THE BUILD HAS STARTED AS IT IS DEEMED ACCEPTANCE OF PRODUCT!**

## Contents

Thank you for your purchase	3
Electrical & Tool requirements	4
Box contents	5
Left Back Panel to Right Back Panel Install	6
Bench Side Upright Install	7
Bench Topper Install	8
Bench Panel Install	9
Fixed Glass Panel Install	10
Door Install	11
Door Handle Install	12
Roof Install	13
Heater and Guard Install	14
Temperature Gauge Install	15
Connecting the Electrics	16
Control Panel Instructions	17
Before First Use—IMPORTANT	18
Sauna Room Safety Guide	19
WEEE Compliance Statement	19



Thank you for your recent purchase of an Insignia Sauna. Please read this booklet with great care to ensure you get the best out of your build and have a Sauna that will last for many years to come! Like everything, in order to obtain a first class product that will serve you well for many years, the effort and correctness put into the assembly will reflect in the quality of your finish.



## Electrical Requirements Model RW109

Voltage Rating 220-240AC

Frequency Rating 50Hz

Power Rating 8000 Watts

Total Amperage 33.3 Amps

Always consult a qualified Electrician before connection as to suitability

Always Obtain Relevant Certification (minor Works Part P etc)

This Sauna **must comply with current UK regulations**

Your electrical contractor will understand **ALL** legal requirements of connection before undertaking any work or installation.

### **UNDER NO CIRCUMSTANCES UNDERTAKE THIS YOURSELF**

Note for electrician:

1) Connect within current laws and IP directives.

2) (Preferred) Wire into isolated fused feed connecting directly to the house consumer/service box.

**Always** use protection against electrical surge. Your shower should be treated the same as a home computer. A surge protector should eradicate the possibility of burn out.

Subject to connection type, electrical work needs to be signed off by a fully qualified operative by law. Failure to adhere to this will not only void your electrical warranty for your sauna, but could void your house insurance.

## Tools Required

- Scissors
- Knife
- Spirit Level
- Tape Measure
- Philips Screwdriver
- Electric Drill
- Safety Gloves
- Safety Glasses

## What's in the Boxes?

Box Number	Contents	Quantity	✓
Box 1	Back Wall	2	[ ]
	Floor	1	[ ]
	Bench top	2	[ ]
	Roof	1	[ ]
	Heater guard	1	[ ]
	Sauna Bucket	1	[ ]
	Sauna Spoon	1	[ ]
	Thermostat	1	[ ]
Screw Pack	40mm Screw	32	[ ]
	Wooden Dowel	36	[ ]

Box Number	Contents	Quantity	✓
Box 2	Front fixed glass panel	2	[ ]
	Door	1	[ ]
	Front of bench	2	[ ]
	Screw pack	1	[ ]
Box 3	Sauna Heater	1	[ ]
	Sand timer	1	[ ]
	Sauna rocks (box)	1	[ ]

### VERY IMPORTANT

Have you got everything? If not please contact the Insignia directly on **01908 317 512**. Remember **NEVER** book your tradesman until everything has arrived, been checked and is present. No replacement/missing parts can be obtained free of charge during or after the build. Any claims can only be within the timescale permitted (48 hours after delivery) and always **BEFORE** build.

## Step 1 — Placing the two back panels into position

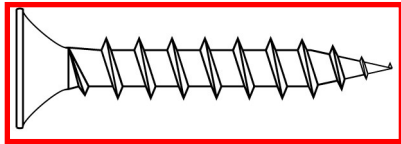

4x 40mm Screws

**Please Note:** Screws connect on the interior of the Sauna

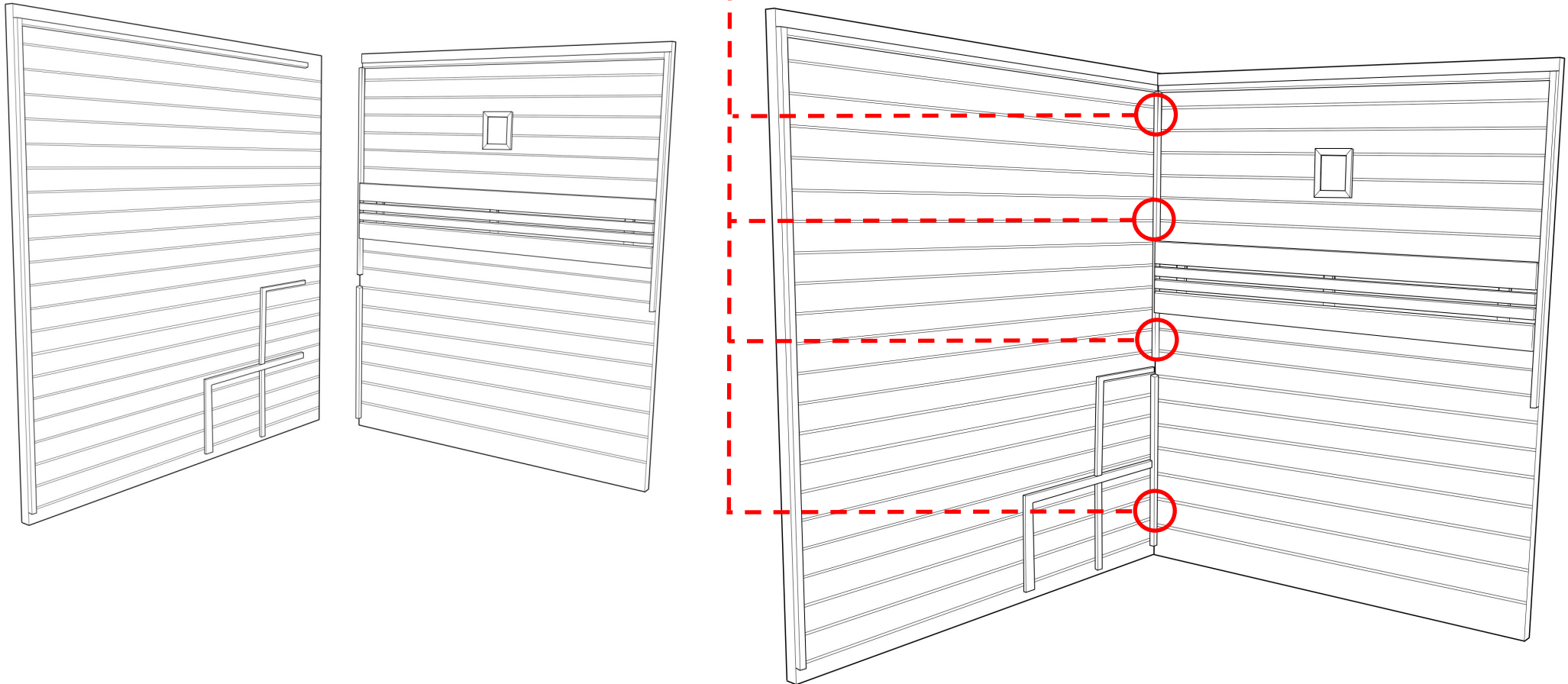

## Step 2 — Bench side upright Install

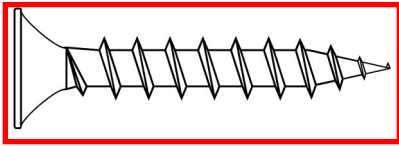

2x 40mm Screws

**Please Note:** Screws connect on the interior of the Sauna

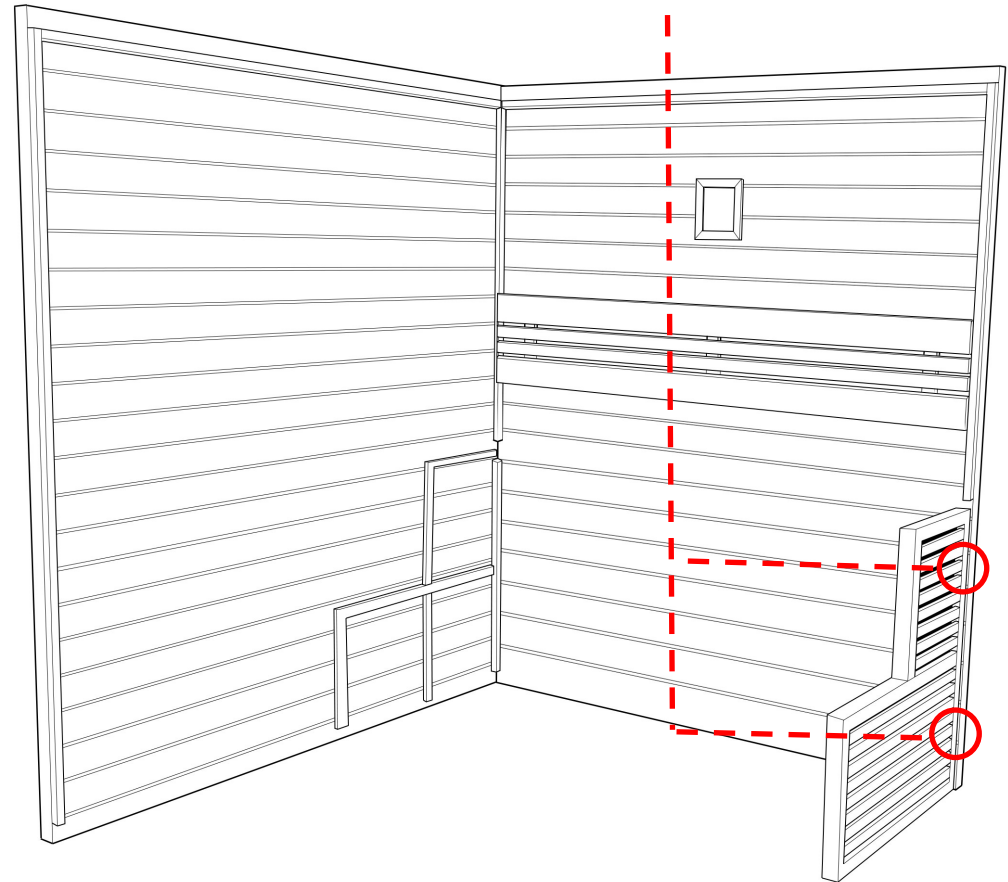
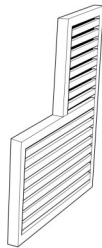
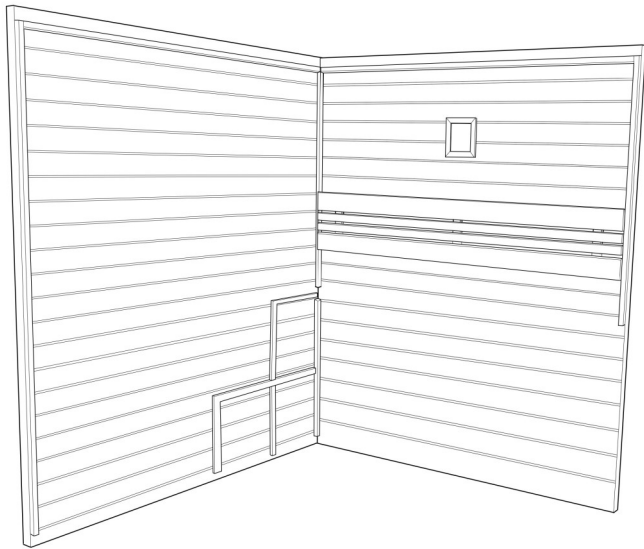

## Step 3 — Installing the bench tops

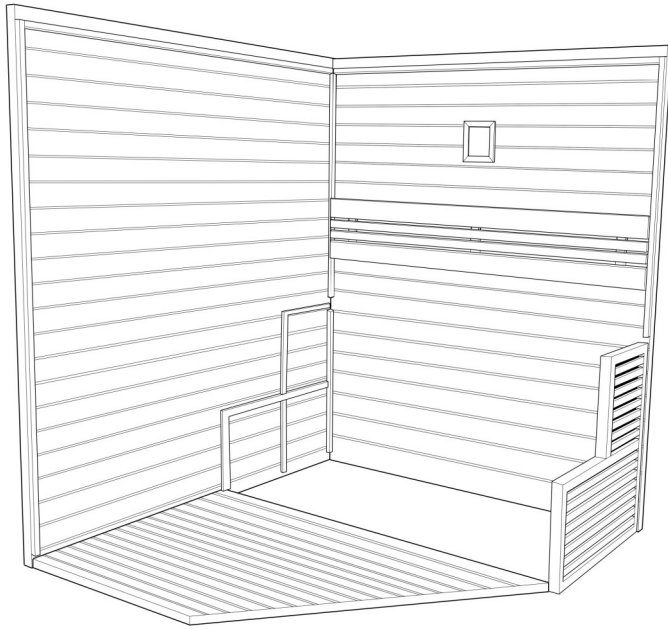

Slide bench toppers onto the framework to slot into position

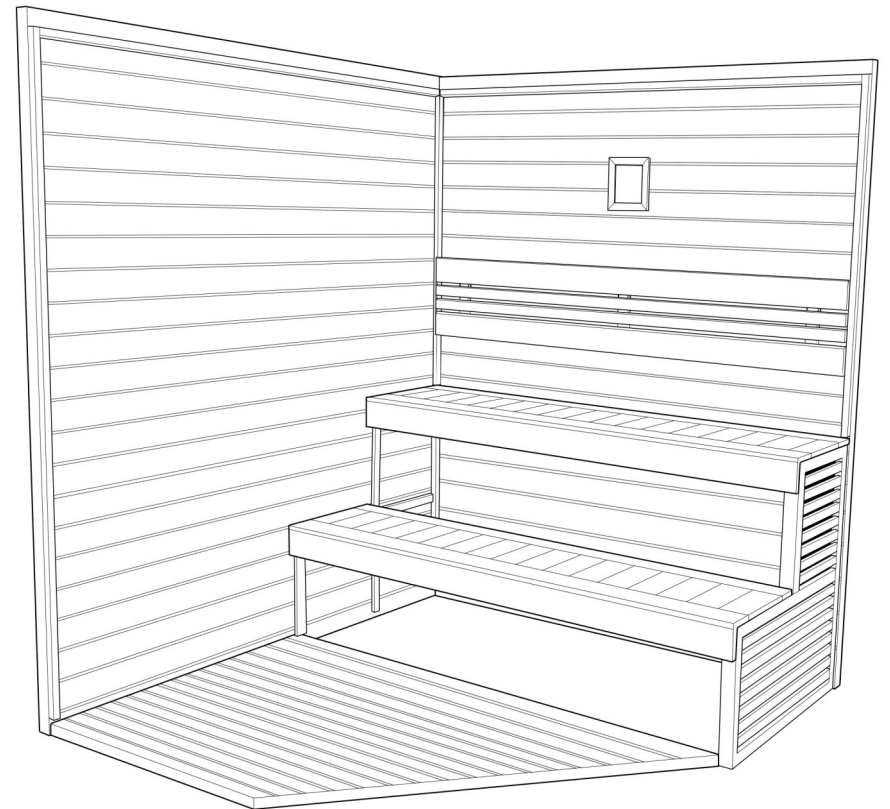
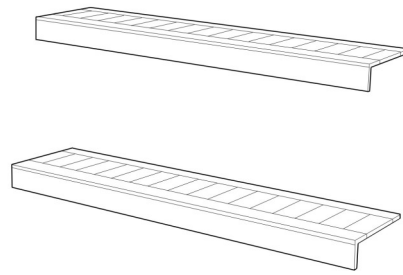



## Step 4 — Installing bench panels

Rotate the front of the bench slightly and slot it up into position.

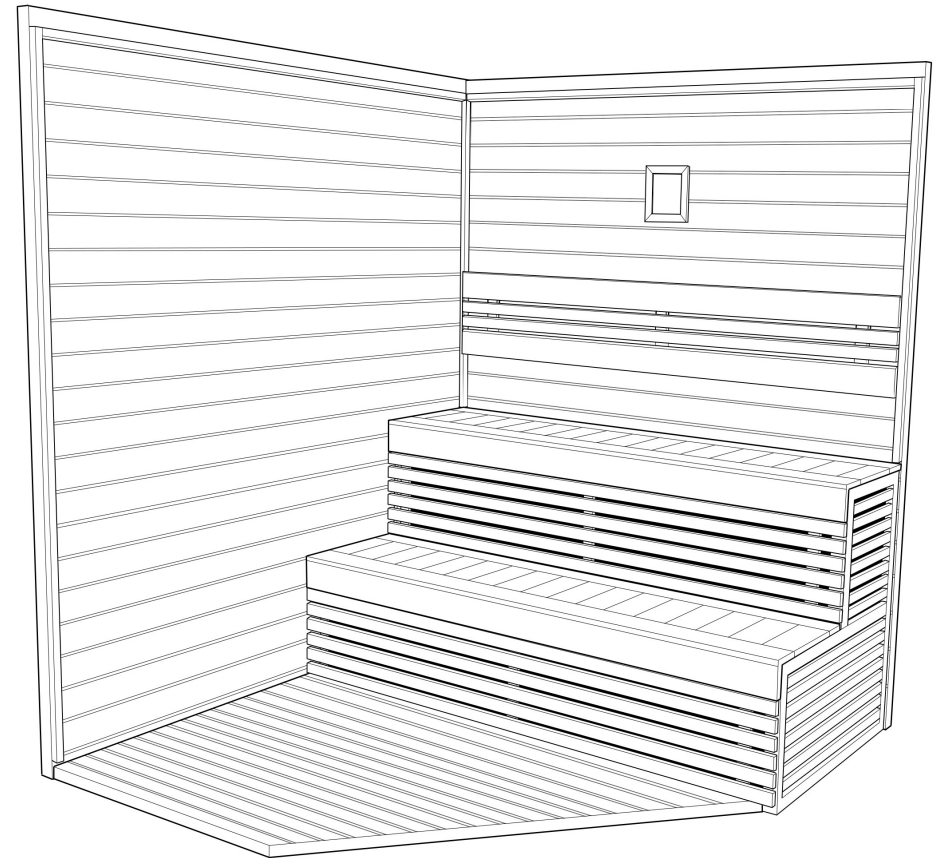
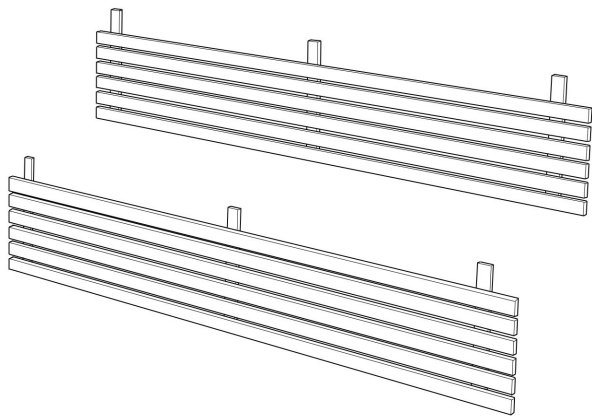
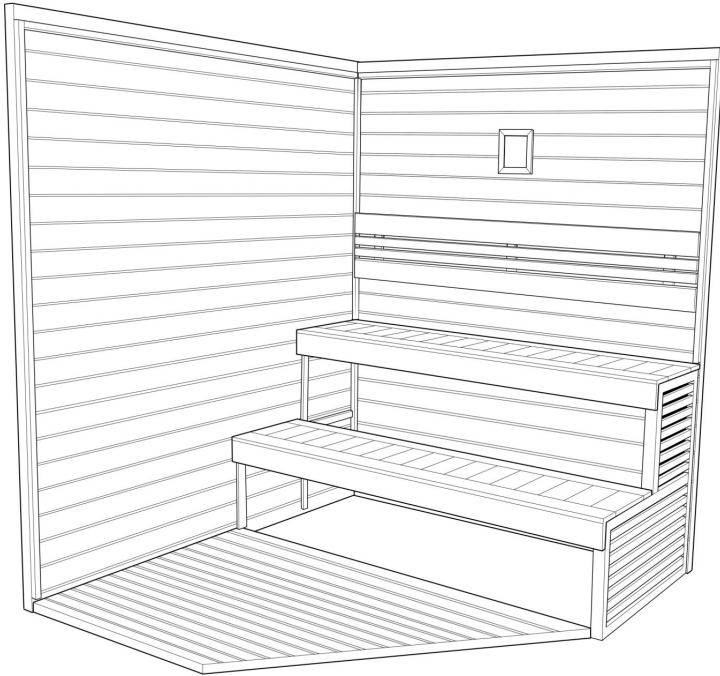

## Step 5 — Installing fixed glass panels

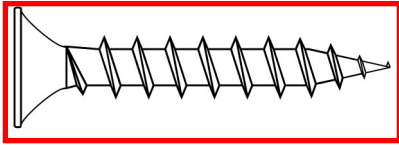

6x 40mm Screws

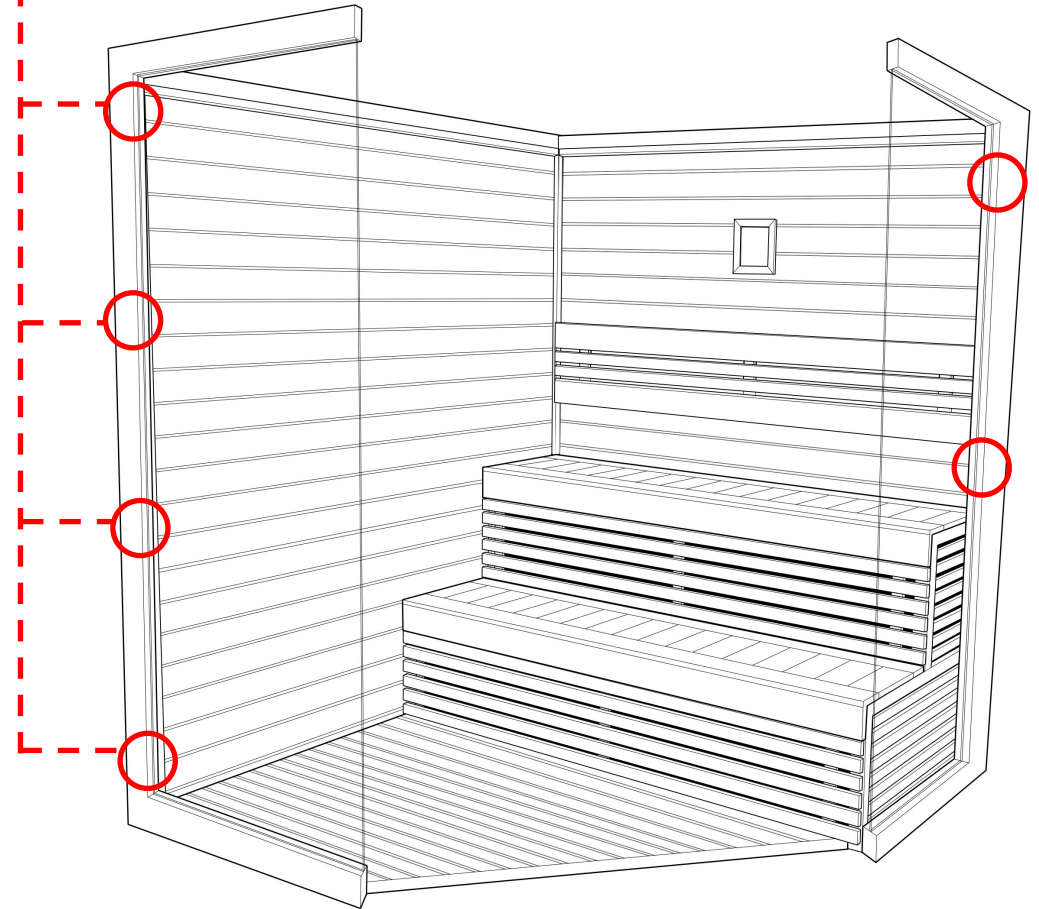
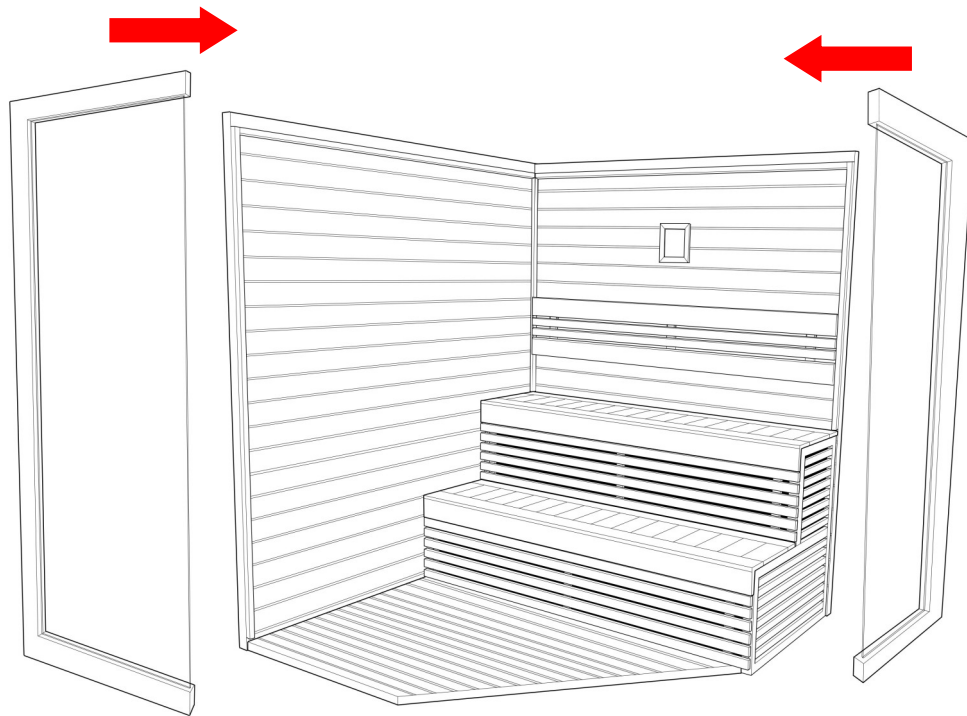

## Step 6 — Installing the door

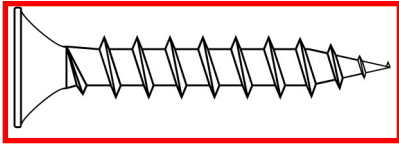

8x 40mm Screws—Place 2 screws in each joint

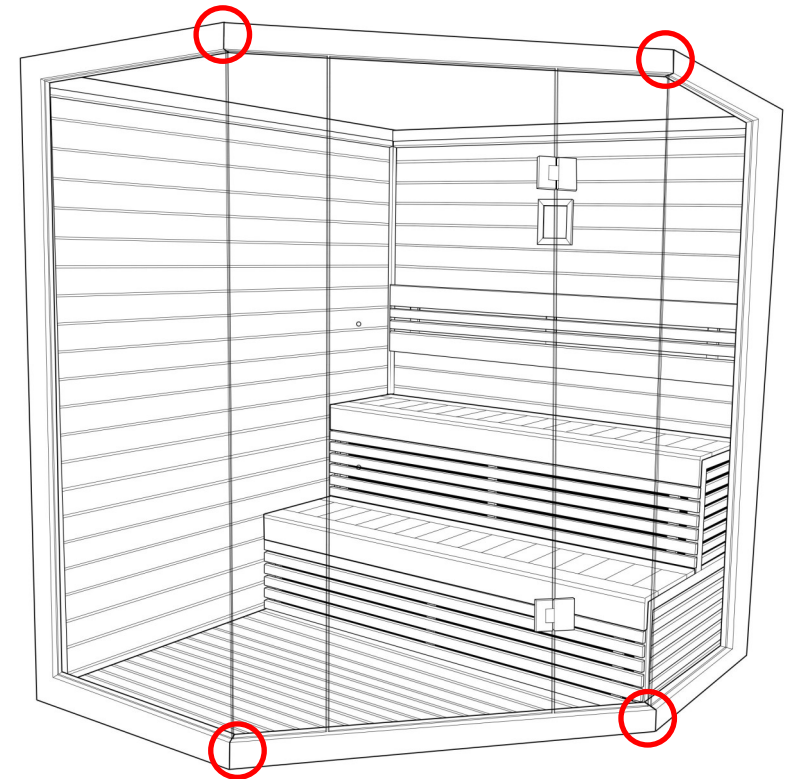
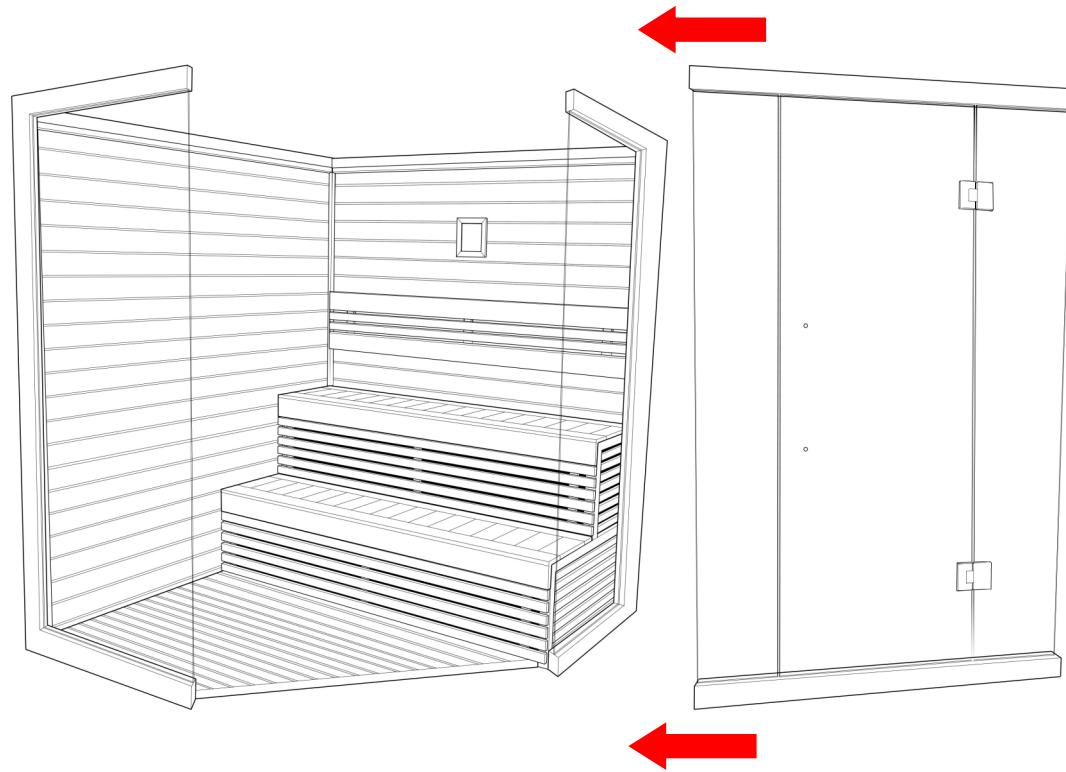

## Step 7 — Door Handle

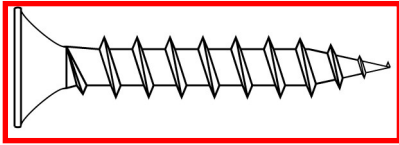

Unscrew the handle, place over the door and reconnect

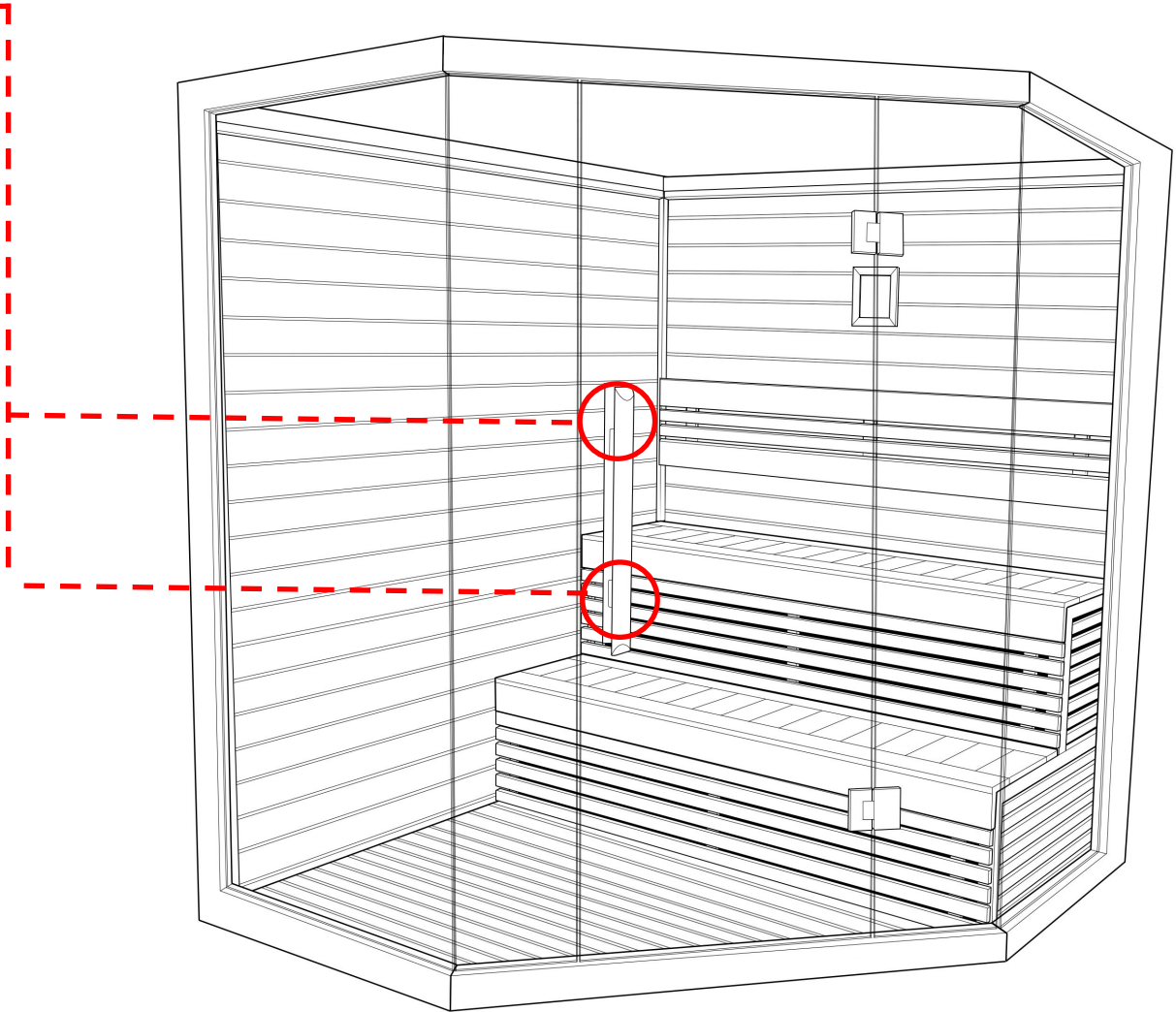
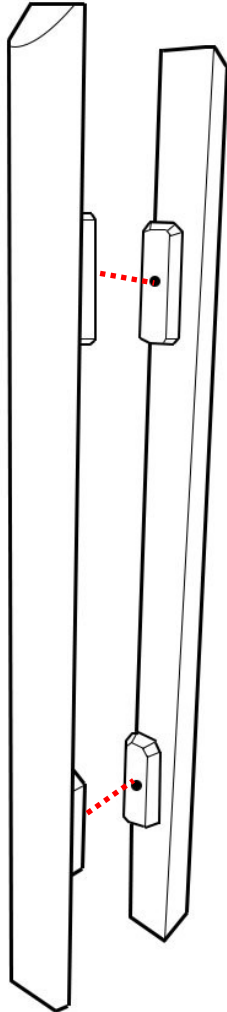

## Step 8 — Roof Installation

The roof slots into position

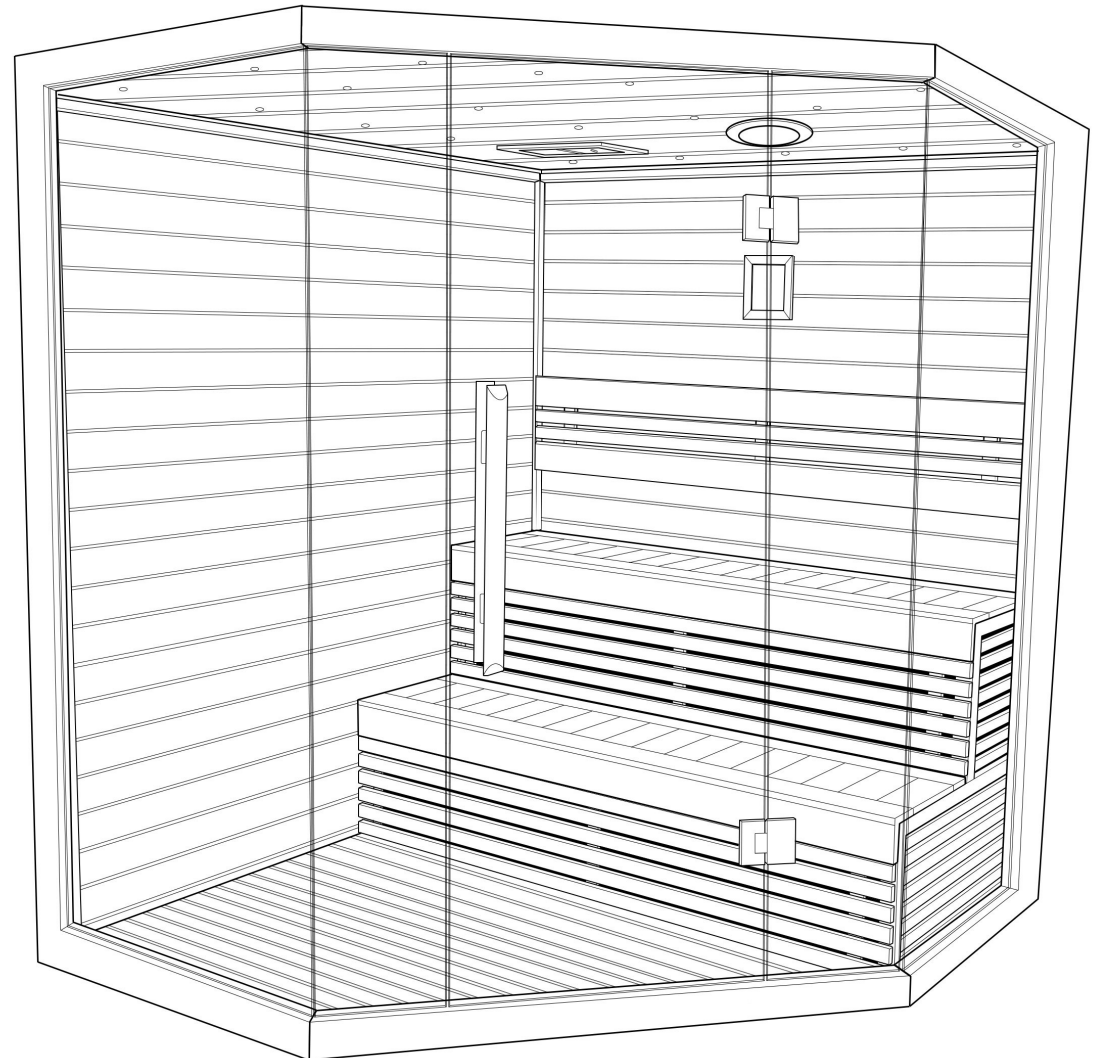
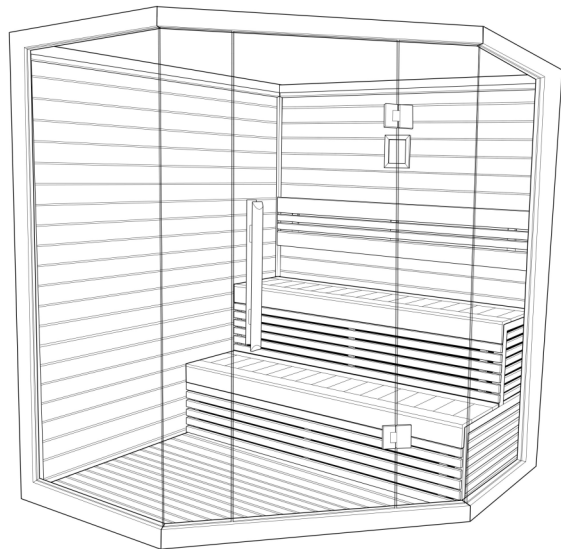
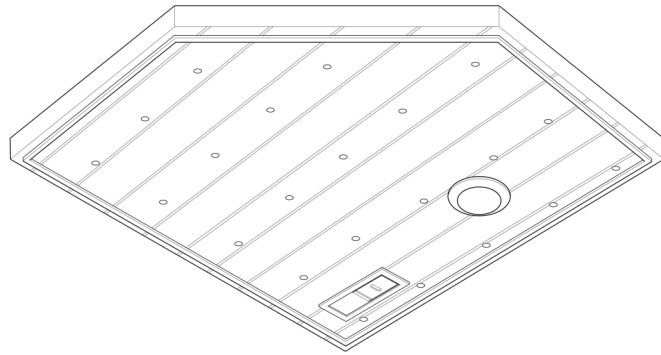



## Step 8 — Installing the heater and heater guard

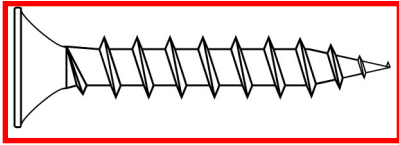

8x 40mm Screws

Slot together and secure with screws.

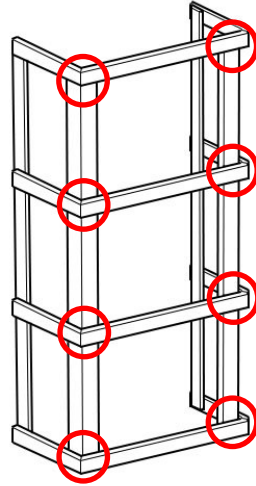

Place heater in position

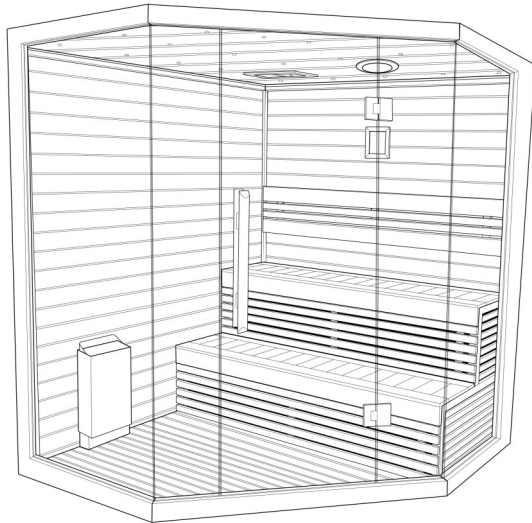

Place over the heater

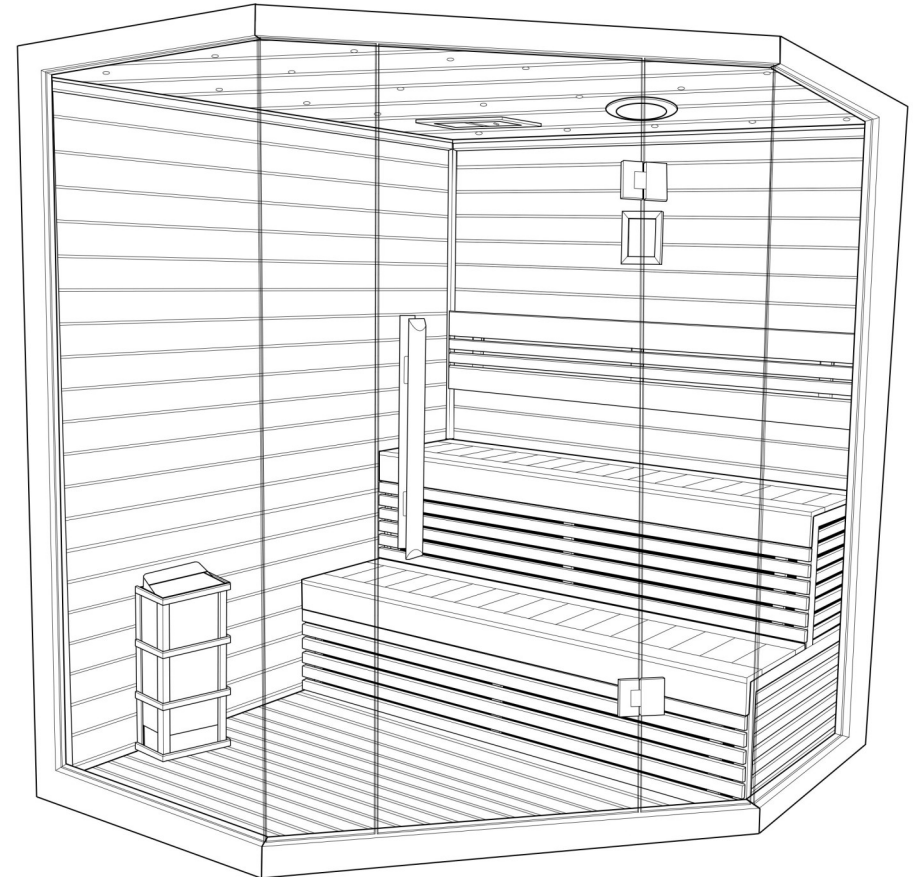

## Step 9 — Installing the temperature guage

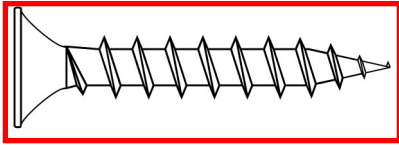

**2x 40mm Screws**

Screw the backplate into position then slot the gauge into the backplate

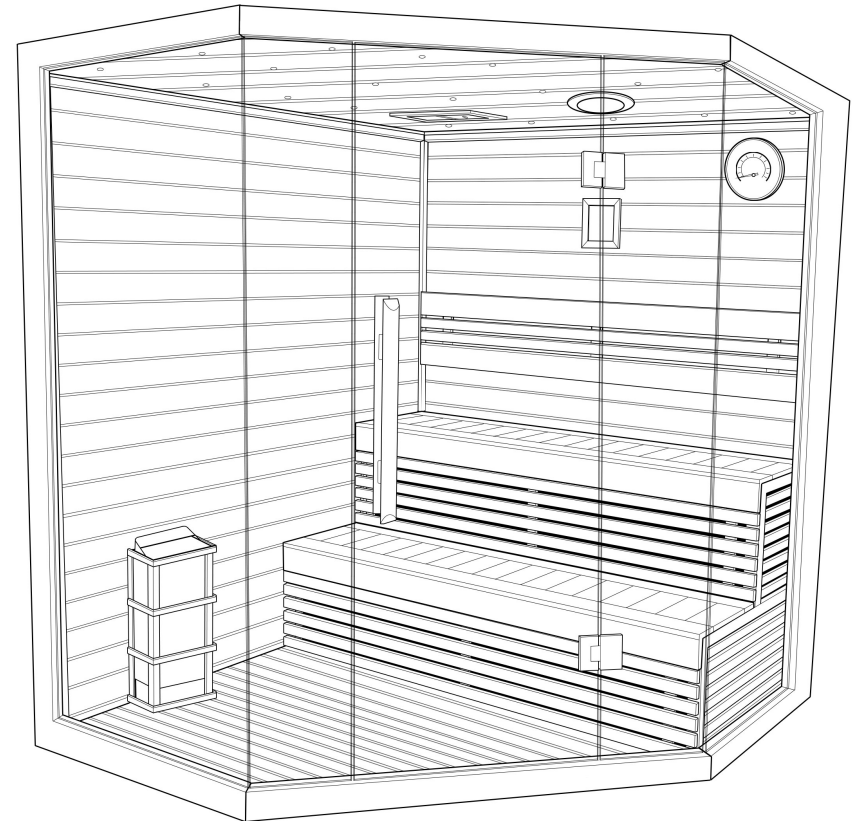
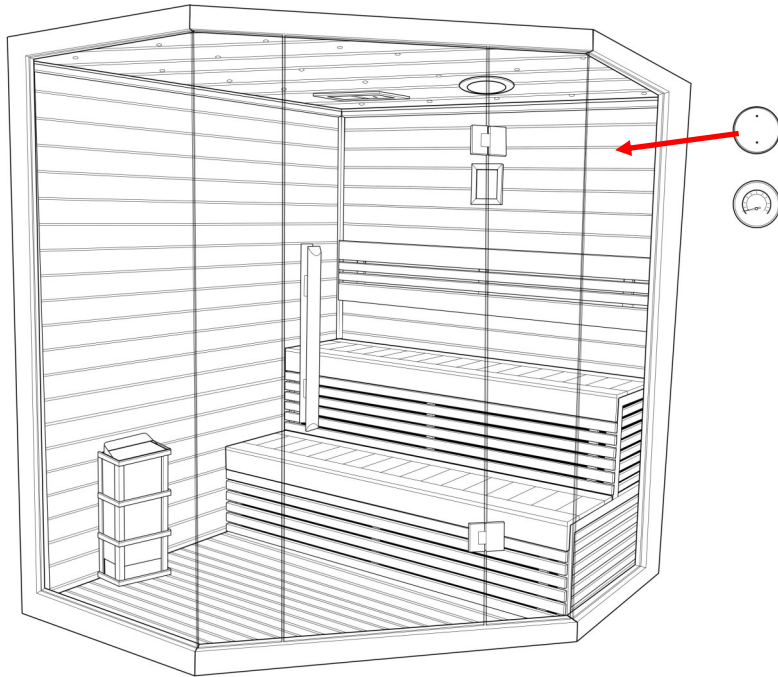

Insert the rocks into the heater. Place smaller rocks between the heating elements and the larger rocks on top.

Now the Sauna is assembled, take the wooden dowels and insert over any screw to give the Sauna a sleek and neat finish.

## Step 8 — Connecting the power

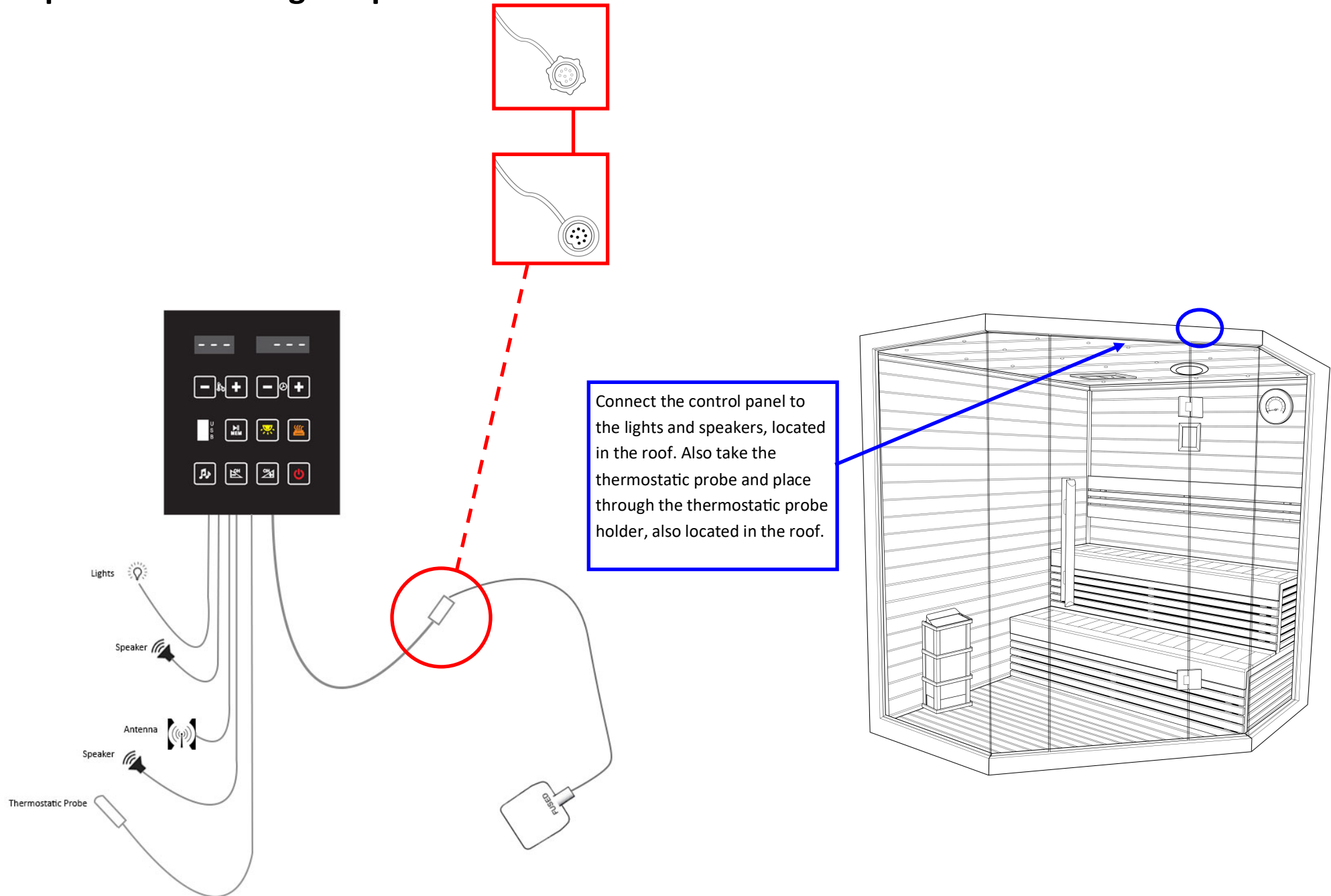

## Control Panel Instructions

### Button 1/2 (Temperature)

Use the plus and minus buttons to change the temperature your sauna will reach.

### Button 3/4 (Time)

Use the plus and minus buttons to change the duration of the sauna session, until the heaters automatically shut off.

### Button 5 (Memory)

Use this button the play or pause the USB, Bluetooth or Radio audio.

### Button 6 (Lights)

Press once for roof light on. Press twice for roof light off and wall lights on. Press three times for roof lights on and wall lights on. Press four times to turn all lights off.

### Button 7 (Sauna)

Use this button to start the heaters for the sauna session

### Button 8 (Audio function)

Use to toggle between radio, Bluetooth and USB audio preferences

### Button 9/10 (Mode)

Use to change the volume, the music tack or radio station

### Button 11 (Power)

Use to power the control panel on or off.

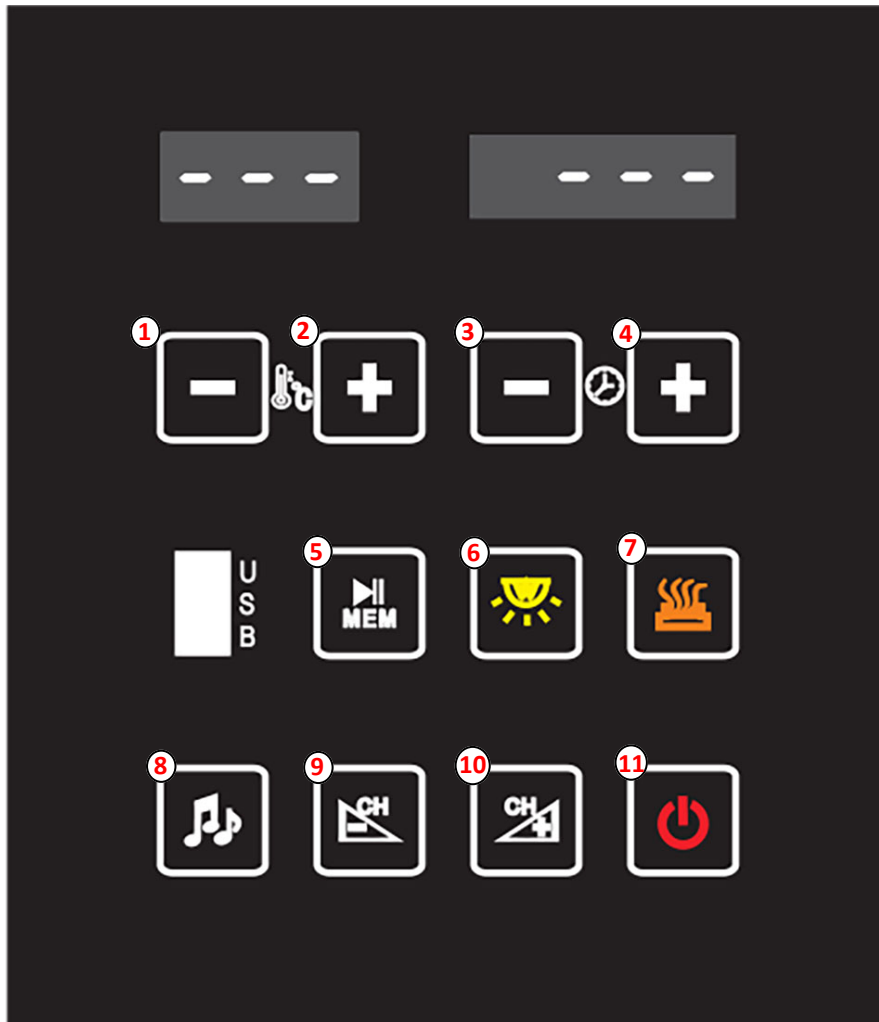

### Bluetooth connectivity:

Press the audio function button (8) until the display reads 'bt' and the Sauna will search for a Bluetooth device. If previously paired, your device and Sauna will sync together and you can begin playing music. To pair, search in your phone for Bluetooth devices and pair with the Sauna.

### Radio Station Tuning

Press the Memory button (5) for 3 seconds after the audio frequency flashes then press again to automatically search. Once this process has been completed, stations will be automatically saved in their designated positions.



## BEFORE FIRST USE — IMPORTANT

1. Ensure the rocks have been thoroughly washed before loading in to the heater.
2. Ensure you place the rocks loosely between the heating elements.
3. Don't over fill the heater, ensure sufficient airflow can be achieved for maximum output.
4. **START UP!** It's recommended that you heat the rocks thoroughly and leave the sauna door closed for a period of 30-40 minutes. The rocks being new may split or spit under the heat as they settle in. This is normal, but we recommend you don't sit in the cabin until you have run the heat through the rocks and they have settled in. You may want to turn the heater off and perform this a second time (when the rocks have cooled down) to be 100% certain they have settled in.
5. It's recommended that the rocks are replaced annually and only use approved Sauna rocks, **NEVER** use any other type of rock.
6. Never touch the rocks when they are fully heated.
7. Pour a ladle of water over the rocks approx. every 5 minutes to increase the air temperature.
8. Pouring too much water on the rocks will lower the room temperature as they will cause the rocks to cool down.
9. Never leave the Sauna unattended.
10. Children should not use the Sauna unsupervised.

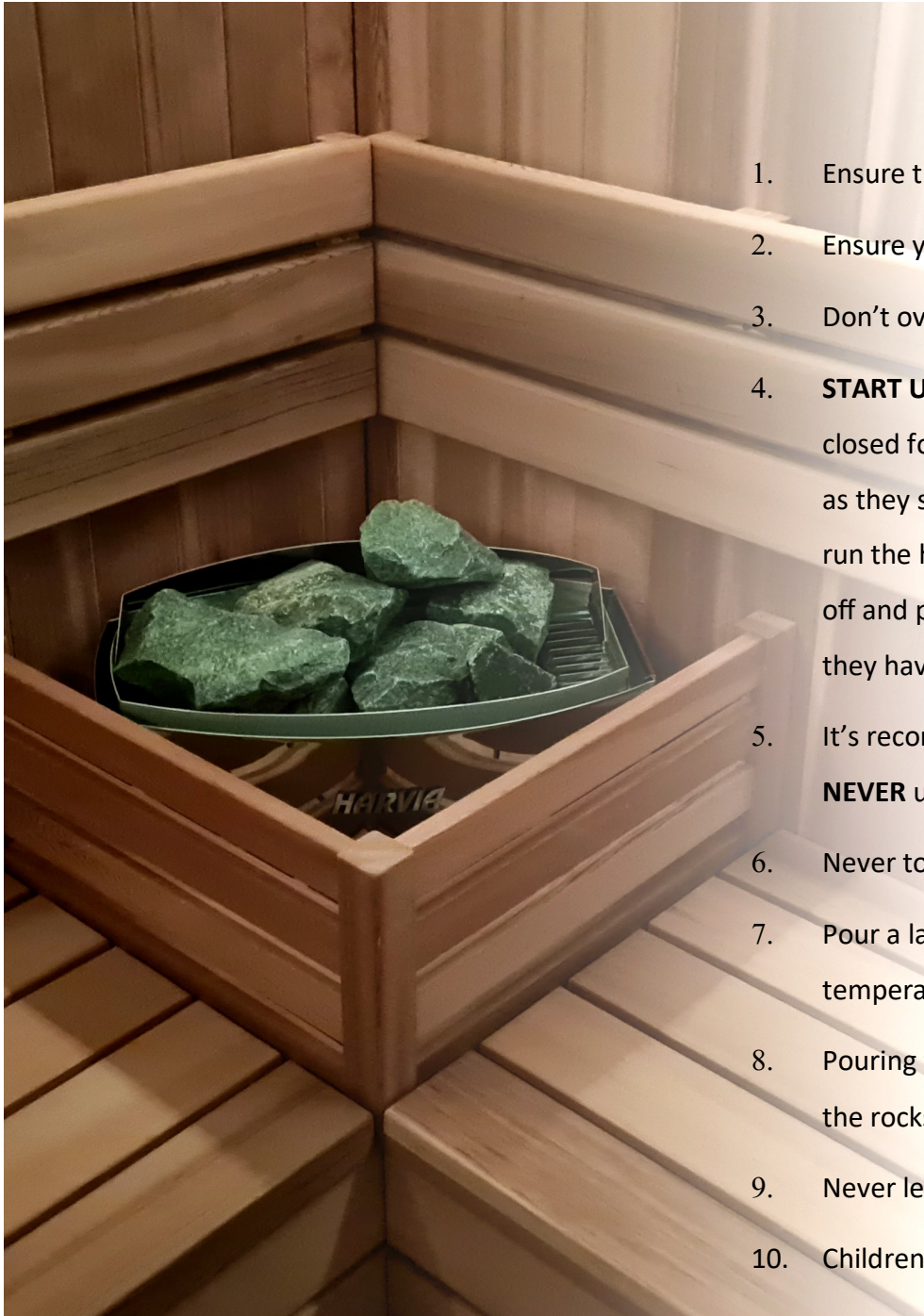



## Sauna Usage & Safety Guide

1. When you turn it on, you **MUST** pour water over the rocks as it's the vapour that creates the heat not the rocks. The rocks alone will never heat up the sauna. Failure to do this could cause the rocks to split and break
2. Never leave children unattended in the Sauna.
3. Regulate the temperature of sauna before session - Pre-heat time 15-30 minutes (from room temperature 20c)
4. Never touch the heater panels whilst in operation, possible burning may occur.
5. Recommended time of use is a maximum of 15 mins. We highly recommend working up in time to this, beginning with 5 minute sessions to get your body used to using a sauna.
6. Stay hydrated during each Sauna session.
7. Exit the sauna immediately if feeling dizzy, faint or short of breath.
8. Do NOT use the sauna if you're pregnant, have a heart condition, have low or high blood pressure. If you're unsure consult your GP before use.
9. If you have any underlying health conditions which you feel could be aggravated by an increase in temperature, consult your GP before use.
10. If you begin to have any issues with your health after using a sauna, stop immediately and consult your GP regarding your symptoms before continuing to use.
11. Consult your GP before using the sauna room if you're on medication at all, especially with drowsy side effects.
12. Never use this sauna if you have been drinking alcohol or under the influence of other substances.
13. Do not put combustible material on the heaters at any time.
14. Always turn power supply off after use.

## WEEE Compliance Statement

The UK Waste Electrical and Electronic Equipment (WEEE) regulations came into force on 2 January 2007. Under this new legislation, producers of electrical and electronic equipment (EEE) have to fulfil certain obligations.

Under the WEEE directive Insignia is considered the producer of certain products we supply and in line with the demands of the legislation we are pleased to offer the opportunity to return these products to us for treatment and recycling.

Insignia products will generally have an identifying mark and the common crossed out wheelie bin label. We accept returns of all products carrying the Insignia brand. All other products are either considered outside the scope of WEEE or Insignia is not technically the producer of these products. Insignia also accepts historic like-for-like WEEE returns. All WEEE returned to Insignia will be recycled in appropriate treatment and recycling centres in accordance with the legislation. If you wish to return any products to us, please send your item(s) to our head office.

Company Contract No. 326457

WEEE Producer No. CBDU64227

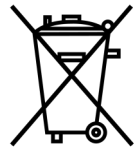

### LABELLING

Products labelled with the WEEE symbol (a crossed out “waste bin”) indicate that the final user should not discard this product along with other household waste, but that it must be collected and treated separately.



### Returns Address for WEEE

Insignia

9a Deans Road, Old Wolverton, Canon Industrial Park, Milton Keynes, Buckinghamshire, MK12 5NA, UK



### EU – Declaration of Performance

Insignia declares that all its products complies with the essential requirements and other relevant provisions of Directive 305/2011/EC. A copy of the Declaration of performance is available from [www.insigniarange.co.uk/ce.aspx](http://www.insigniarange.co.uk/ce.aspx)

Insignia™ is a registered trademark of Maclean International Ltd, 9a Deans Road, Old Wolverton, Canon Industrial Park, Milton Keynes, Buckinghamshire, MK12 5NA, UK

All images are subject to copyright. Images may not be used in any way shape or form with out written permission from Maclean International Ltd. Images are NOT permitted to be saved, printed or uploaded. Violation of copyright laws are punishable by law.

All images are registered with  
ImageTraker

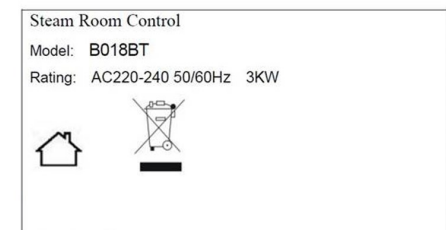
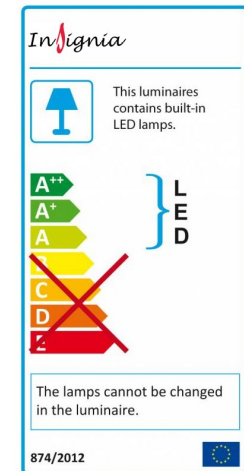

Insignia™ is a registered trademark of Maclean International Ltd

All images are subject to copyright. Images may not be used in any way shape or form with out written permission from Maclean International Ltd. Images are NOT permitted to be saved, printed or uploaded. Violation of copyright laws are punishable by law.