

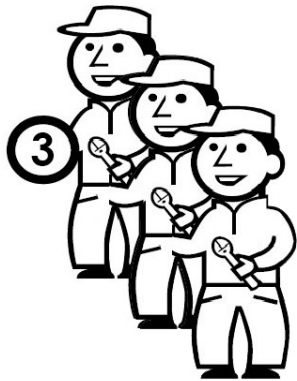

INSTALLATION MANUAL

MXOS1700

Outdoor Sauna Series



30 Day Technical Support:

Call **01908 317512** and request technical support for aiding your installation.

Replacements Parts: Inside of your warranty period visit:

<https://www.insigniashowers.com>, click support and make a warranty claim.

Spares/Replacements Parts: Outside of your warranty period visit

<https://www.insigniashowers.com/replacement-parts.html>



ATTENTION INSTALLERS:

These instructions must be left with the customer

CHECK ALL CONTENTS BEFORE BUILD COMMENCES. NO RETURNS CAN BE MADE ONCE THE BUILD HAS STARTED AS IT IS DEEMED ACCEPTANCE OF PRODUCT!

Contents

Thank you for your purchase	3
Electrical & Tool requirements	4
Box contents	5
Installation Instructions	6
Creating the base	7
Installing the back right upright	8
Installing the back panel	9
Installing the back left upright	10
Installing the right side panel	11
Installing the right front upright	12
Installing the left side panel	13
Installing the front left upright	14
Electric box install	15
Installing the top frame	16
Floor placement	17
Placing the bench front	18
Under seat support frame install	19

Bench seat install	20
Back rest install	21
Installing the fixed glass panel	22
Installing the inner roof	23
Installing the big roof	24
Installing the heater and heater guard	25
Installing the door handle	26
Installing the door	27
Installing the accessories	28
Control Panel Instructions/Operation	29
Before First Use—IMPORTANT	32
Sauna Room Safety Guide	33
WEEE Compliance Statement	34



Thank you for your recent purchase of an Insignia Sauna. Please read this booklet with great care to ensure you get the best out of your build and have a Sauna that will last for many years to come! Like everything, in order to obtain a first class product that will serve you well for many years, the effort and correctness put into the assembly will reflect in the quality of your finish.

IMPORTANT!

OUTDOOR SAUNAS

CHOOSE BUILD DAYS WITH LOW HUMIDITY / NO RAIN / WET WEATHER IN COMING DAYS.

ALWAYS WOOD TREAT EXTERNAL PANELLING WITHIN 24 HOURS OF COMPLETION.

(Failure to do so can cause panel warp)

Electrics

Stove

Harvia 4kW 240 volt 3 phase dedicated feed connection or 240 volt single phase option

Infrared Heaters

4 x 330 watt (1320 watts total) 240 volt single phase connection

Other

LED lighting, radio, Bluetooth etc 240 volt single phase 120 watts

Total rating 5940 watts

Amperage 14.3 amps

Always consult a qualified Electrician before connection as to suitability Your electrical contractor will understand ALL legal requirements of connection before undertaking any work or installation.

UNDER NO CIRCUMSTANCES UNDERTAKE THIS YOURSELF. ALWAYS USE AN ELECTRICAL CONTRACTOR AND ENSURE LEGAL CERTIFICATION IS GIVEN ON COMPLETION

The MXOS1700 has provision for 240 volts. The 4kW stove has facility for the connecting options. Your qualified electrician will advise on the method they feel best suits your situation and electrical supply along with any potential benefit either may have.

Tools Required

- Scissors
- Knife
- Spirit Level
- Tape Measure
- Philips Screwdriver
- Electric Drill
- Safety Gloves
- Safety Glasses

What's in the Boxes?

Contents	Quantity	✓
Back Panel	1	[]
Left Panel	1	[]
Right Panel	1	[]
Fixed Glass	1	[]
Door	1	[]
Inner Roof	1	[]
Big Roof	1	[]
Sauna Heater	1	[]
Heater Guard	1	[]

Contents	Quantity	✓
Light	1	[]
Door Handle	1	[]
Sauna Rocks	1	[]
Backrest	1	[]
Bench Top	4	[]
Bench Vertical Supports	4	[]
Under Bench Support	4	[]
Screw Pack	1	[]

VERY IMPORTANT

Have you got everything? If not please contact the Insignia directly on **01908 317 512**. Remember **NEVER** book your tradesman until everything has arrived, been checked and is present. No replacement/missing parts can be obtained free of charge during or after the build. Any claims can only be within the timescale permitted (48 hours after delivery) and always **BEFORE** build.

Installation Instructions

Please note : Must be installed on a solid and level base. Use bearers to allow gap to prevent damp transfer.

Maintenance Instructions

Please note : Like all timber products, such as garden sheds and fencing, garden saunas require full exterior wood weatherproofing treatment after installation to ensure long life and prevention of water ingress.

Step 1 — Creating the base

Create a square using the 4 bottom struts.

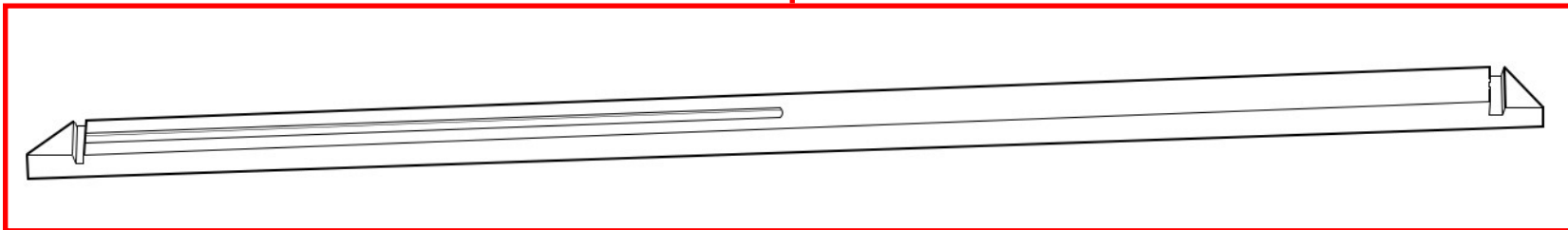
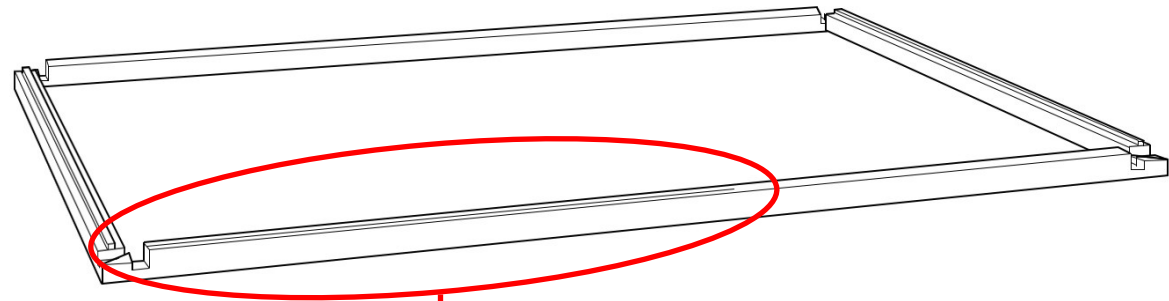

Note: The front strut has a groove cut out for the front fixed glass panel. Make sure this strut is at the front of the square.

Step 2 — Installing rear right upright



There will be 3 screw connections on two faces of the upright. They should face towards the back bottom strut and right bottom strut.

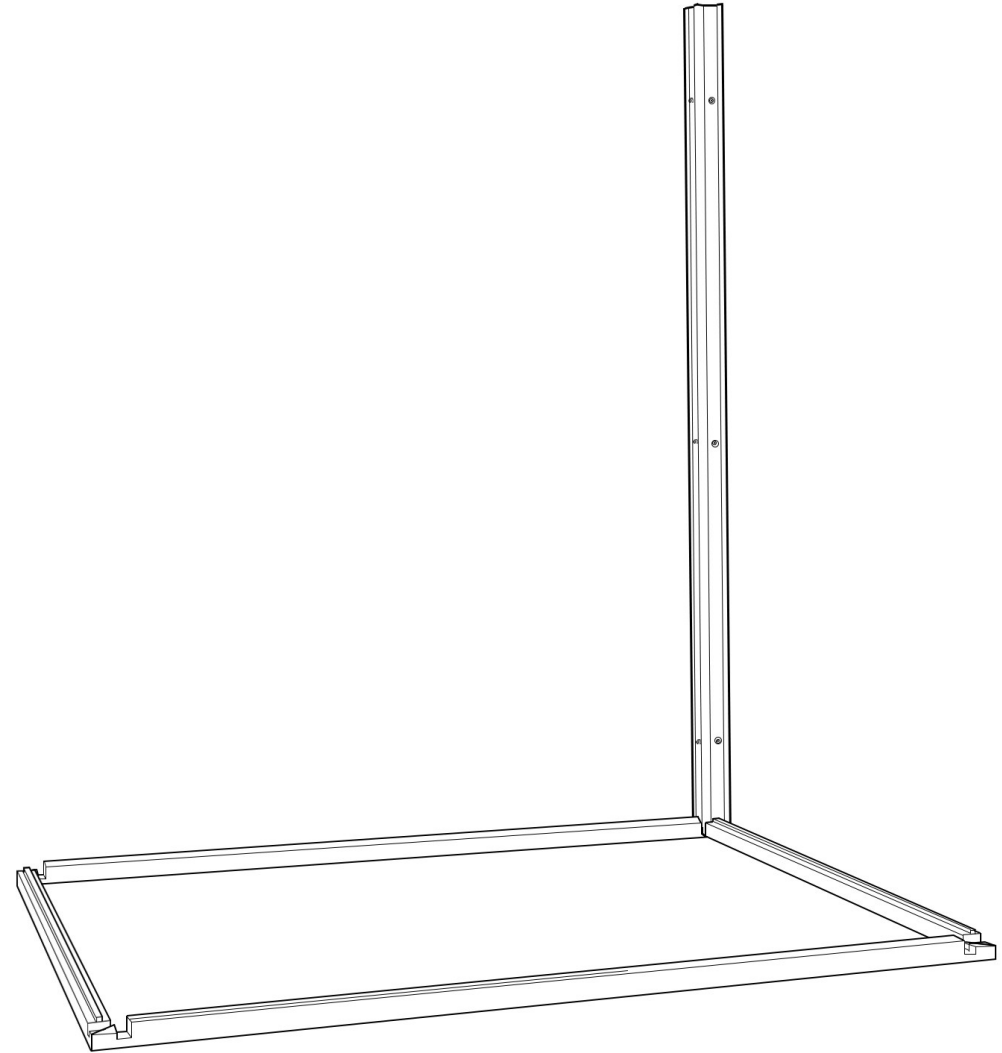
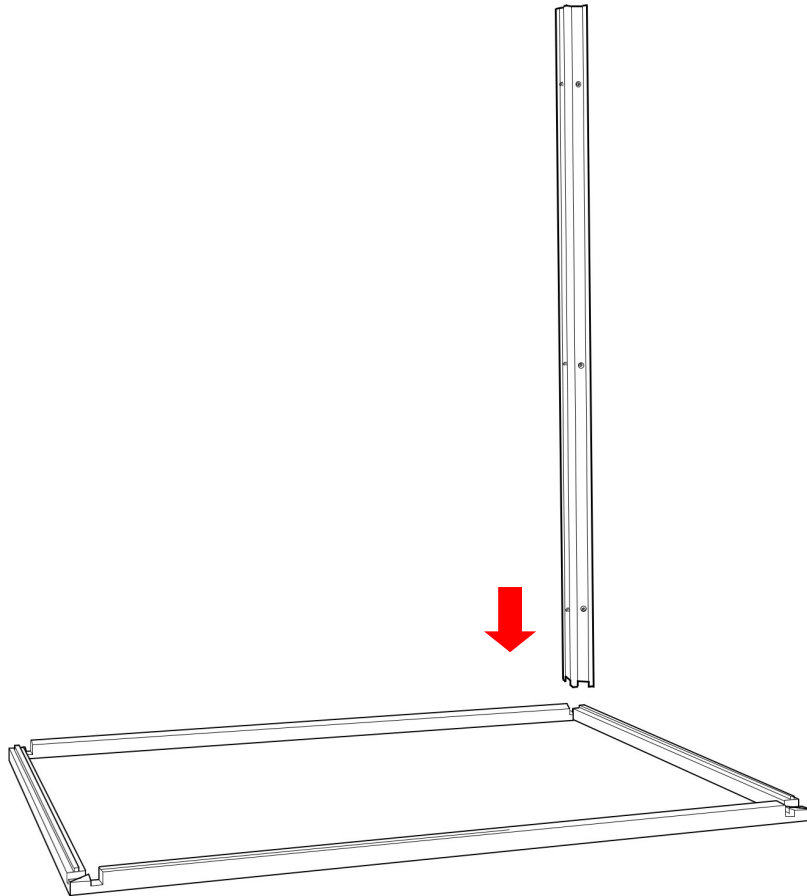

Step 3 — Installing the back panel

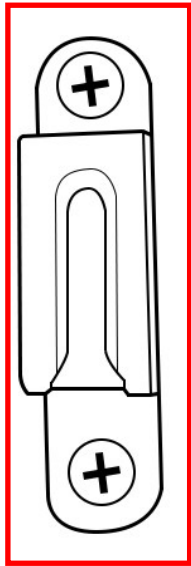

Lift the back panel and slide the brackets over the screw fixings and lock into position. Also ensure you push the panel down onto the back bottom strut and ensure they lock together.

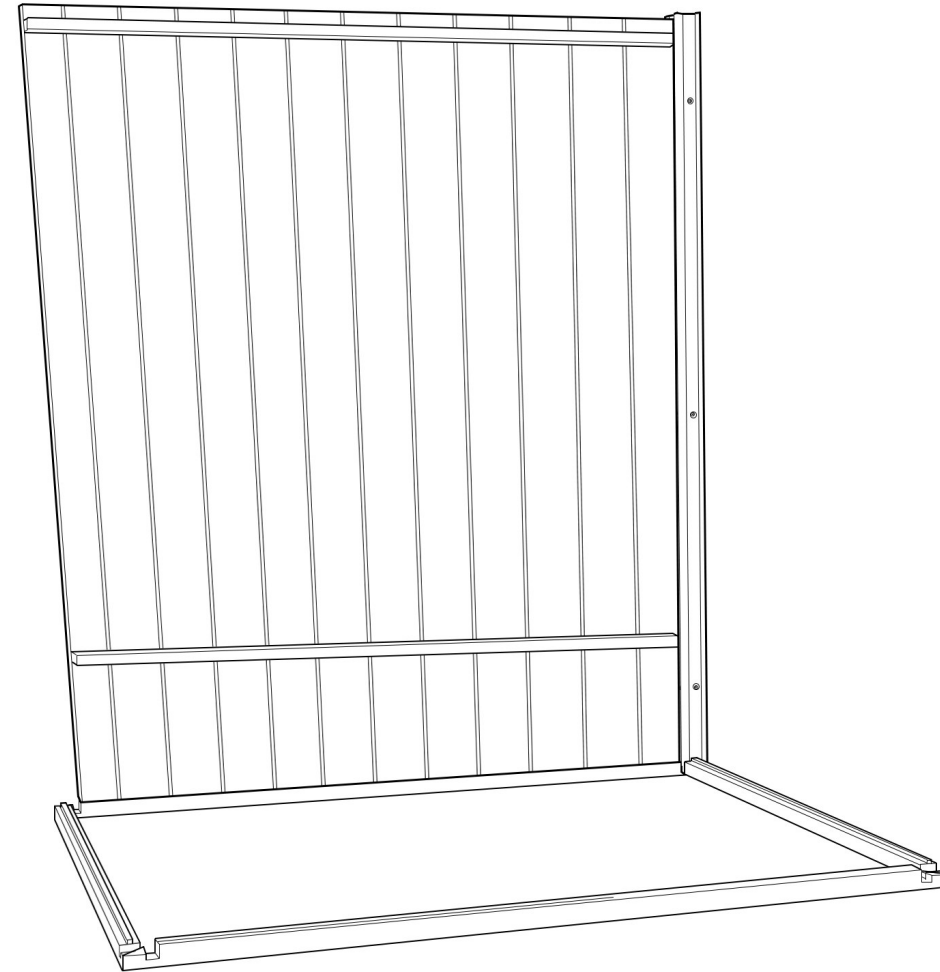
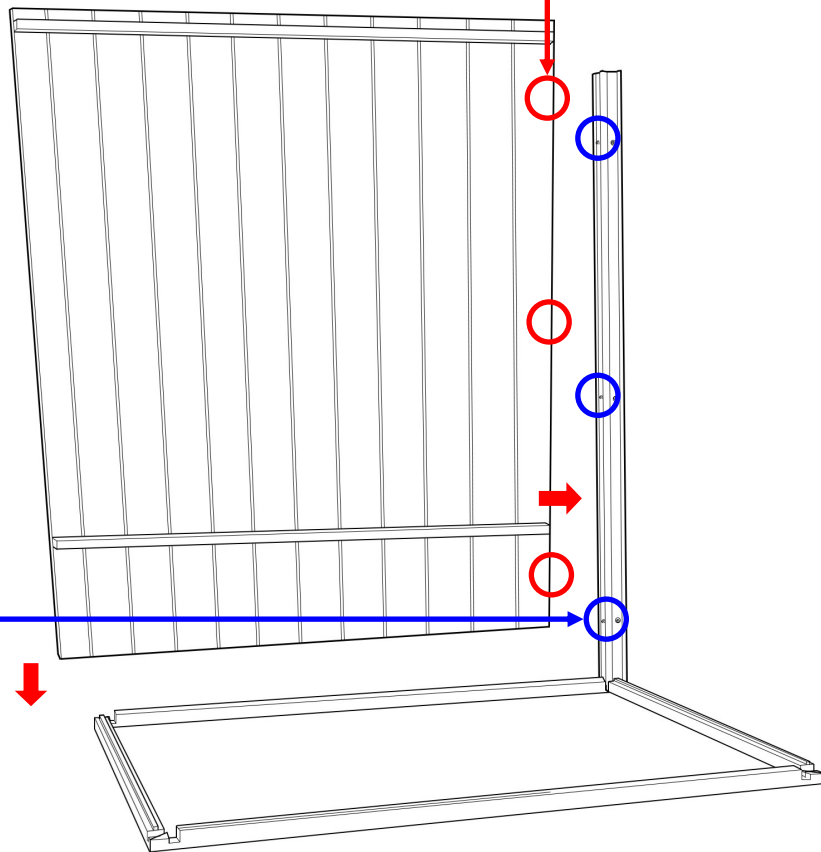

Step 4 — Installing the back left upright

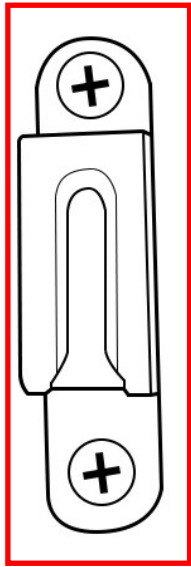

Tilt the back panel up in order to get the back left upright to slot into the brackets. Connect and push the right back upright down and secure into position.

There will be 3 screw connections on two faces of the upright. They should face towards the back bottom strut and left bottom strut.

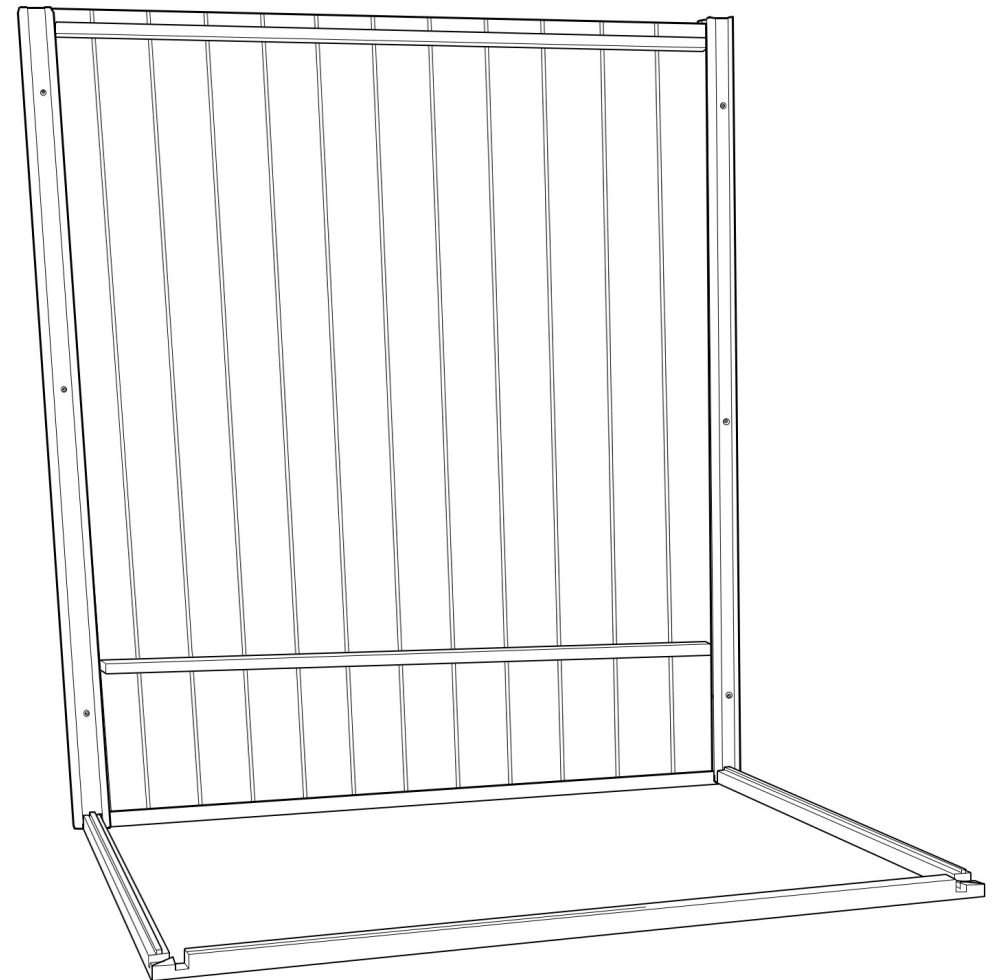
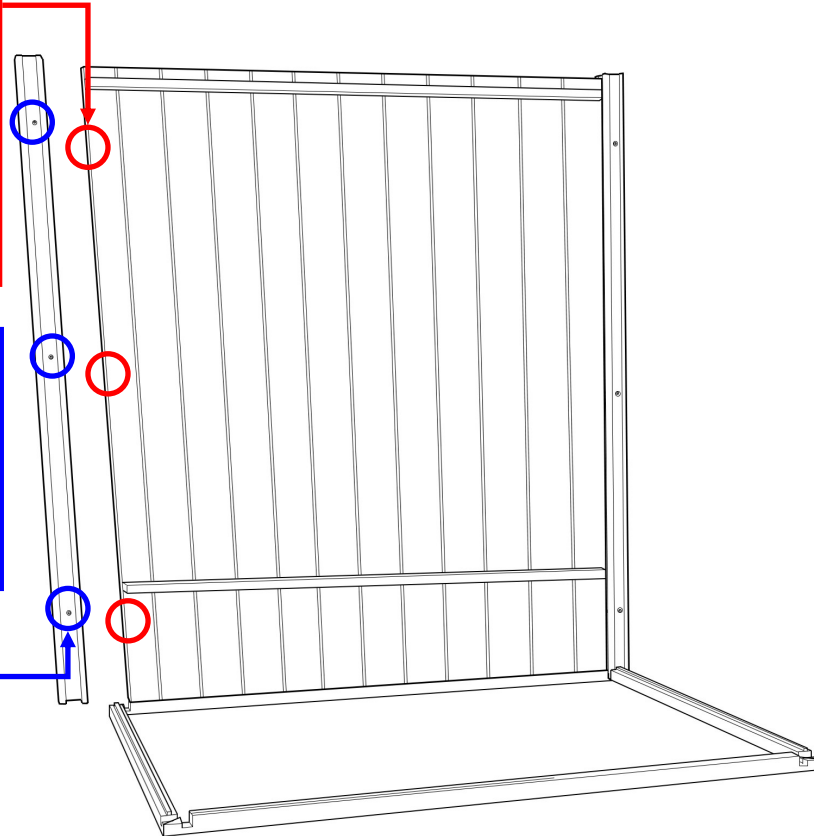

Step 5 — Installing the right side panel

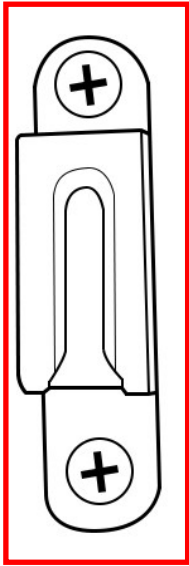

Lift the side panel and slide the brackets over the screw fixings and lock into position. Also ensure you push the panel down onto the right bottom strut and ensure they lock together.

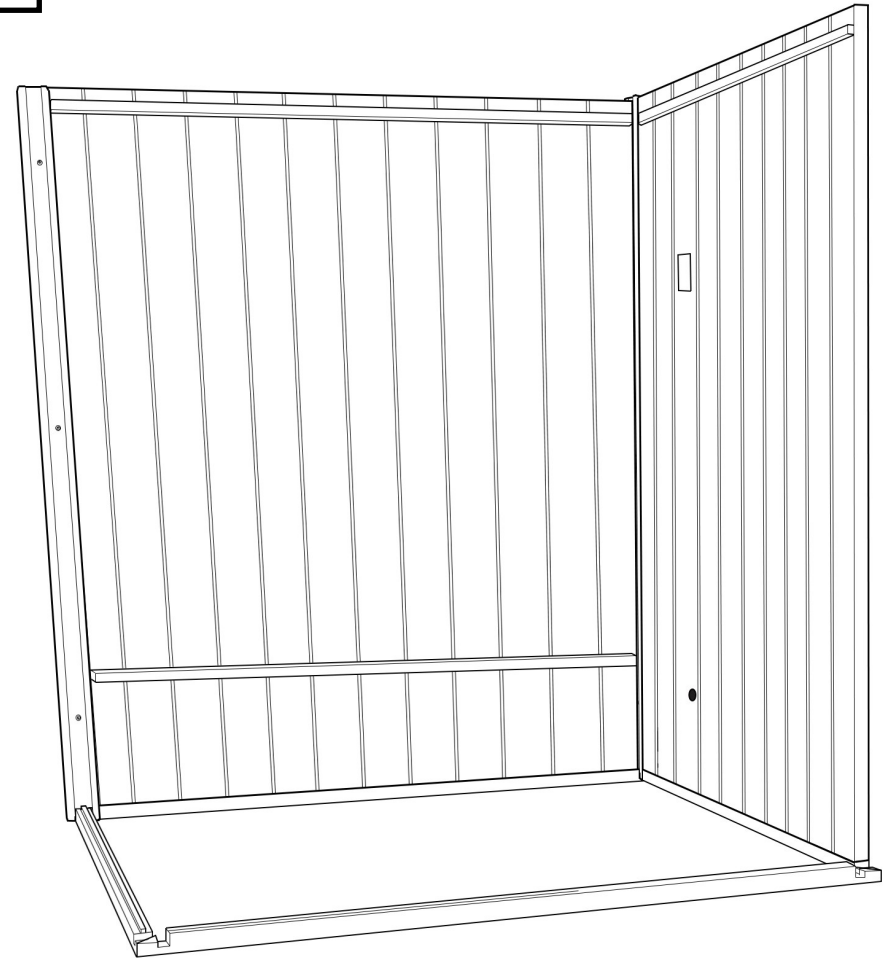
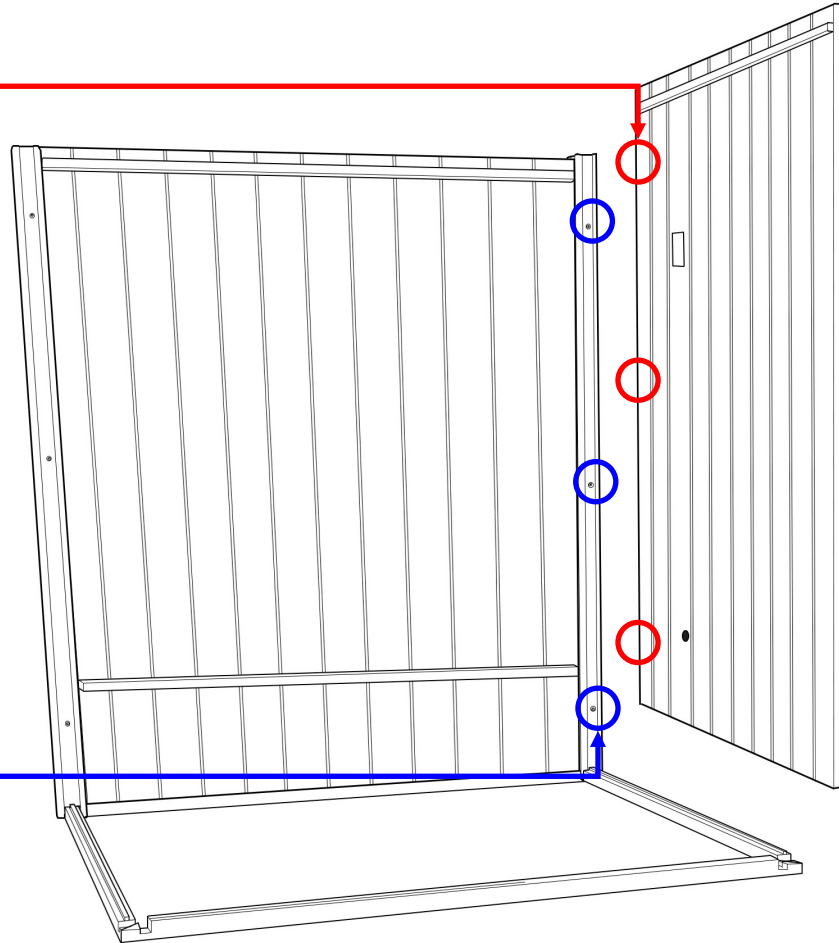

Step 7 — Installing the right front upright

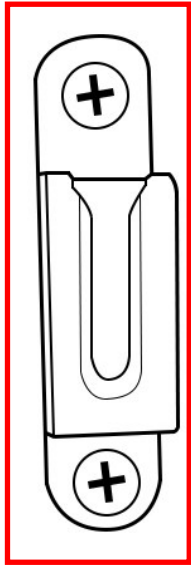

Slot the front right upright onto the side panel and push down to secure in position.

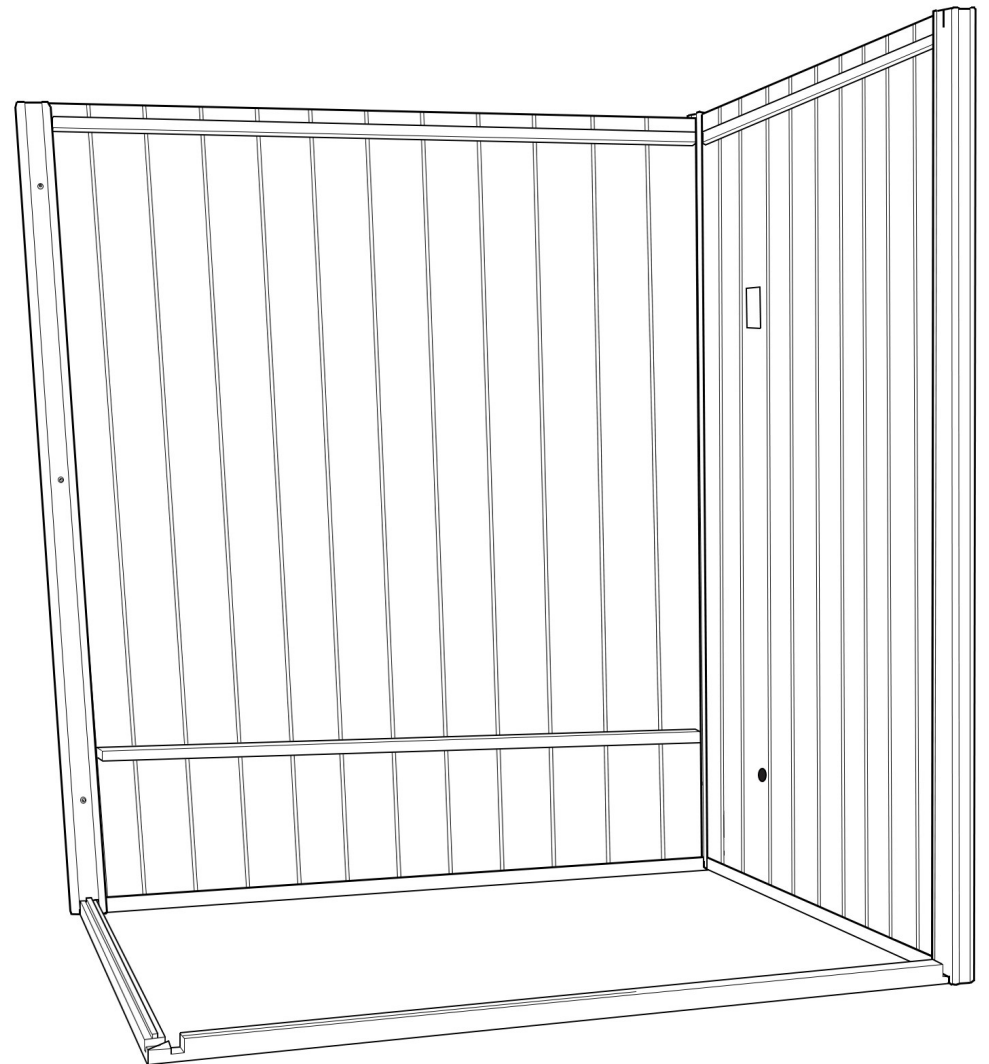
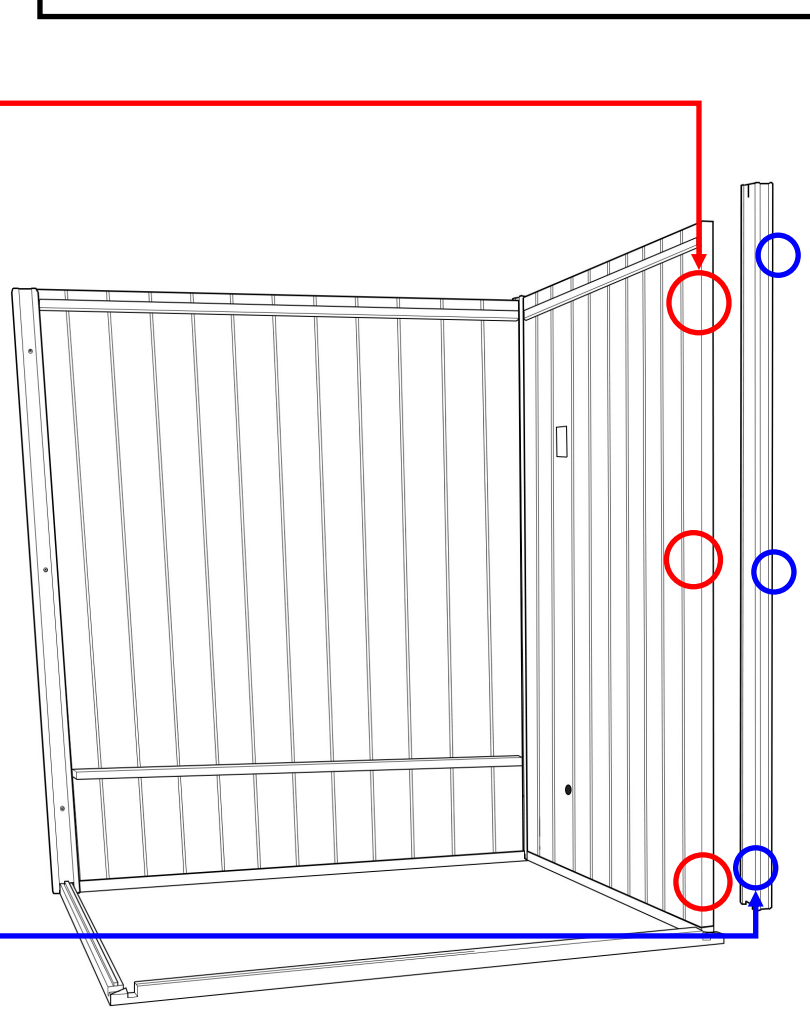

Step 8 — Installing the left side panel

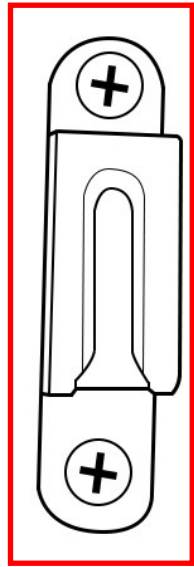

Lift the left side panel and slot down onto the back left upright and locking in place on the bottom left strut.

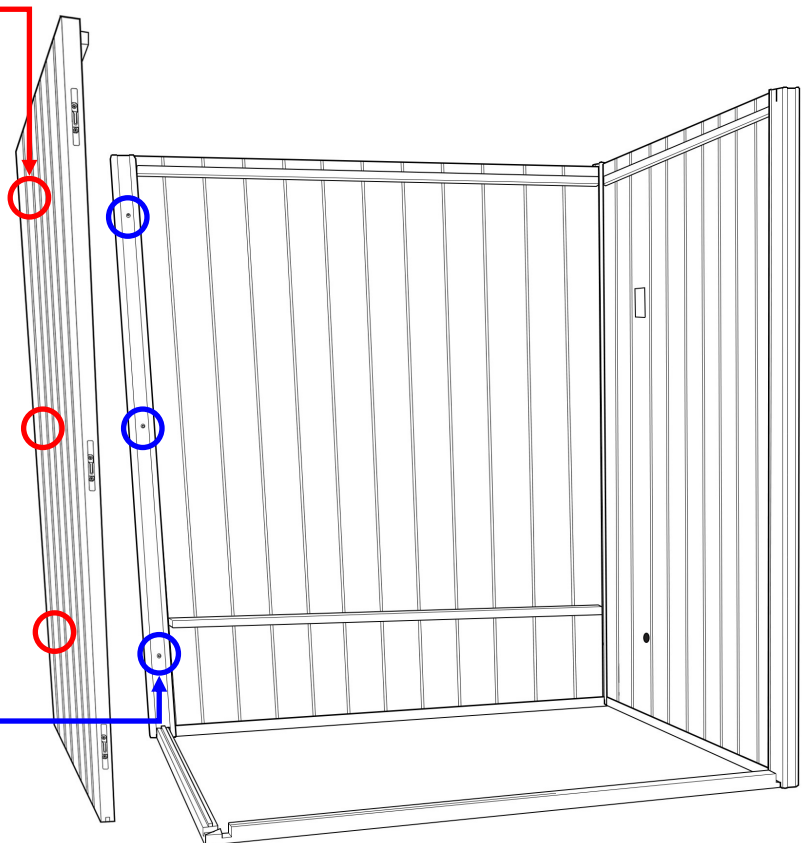
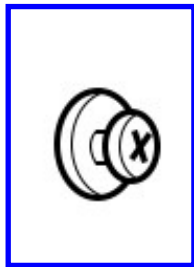

Step 9 — Installing the front left upright

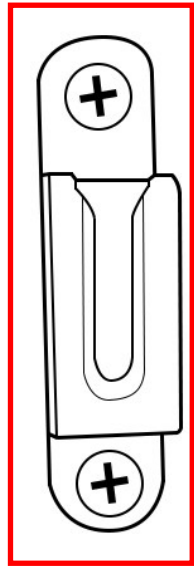

Slot the front left upright onto the side panel and push down to secure in position.

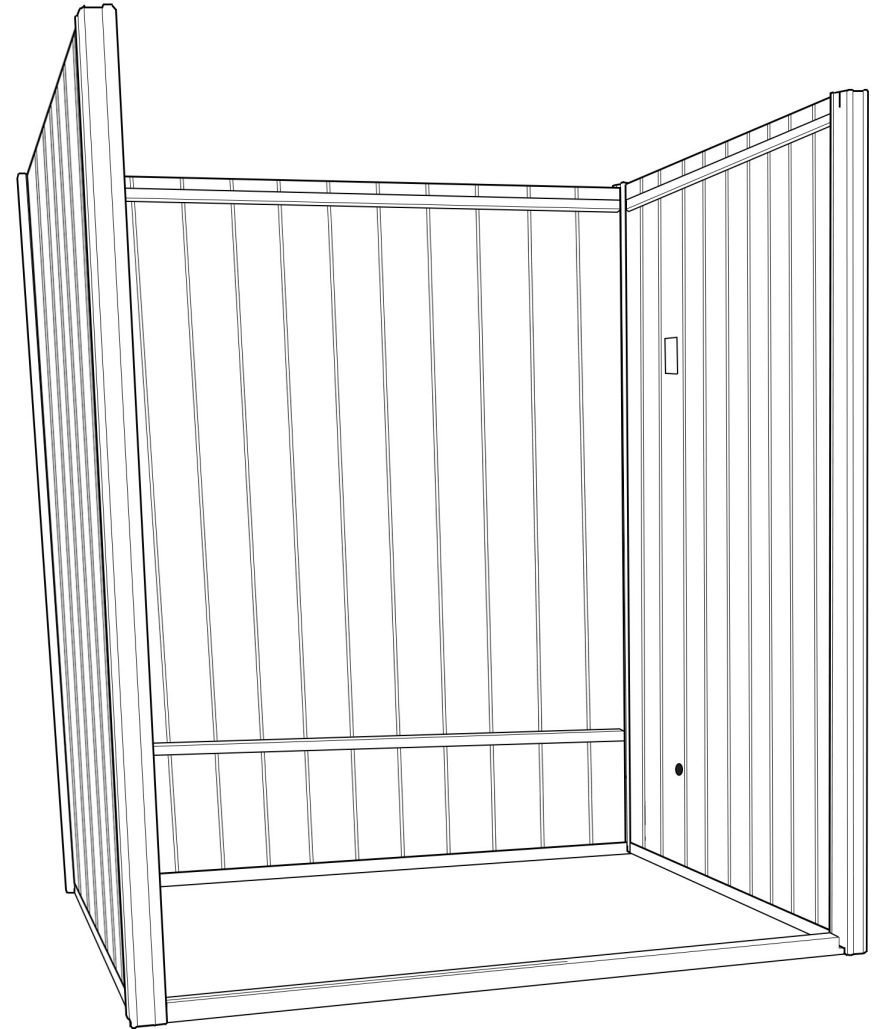
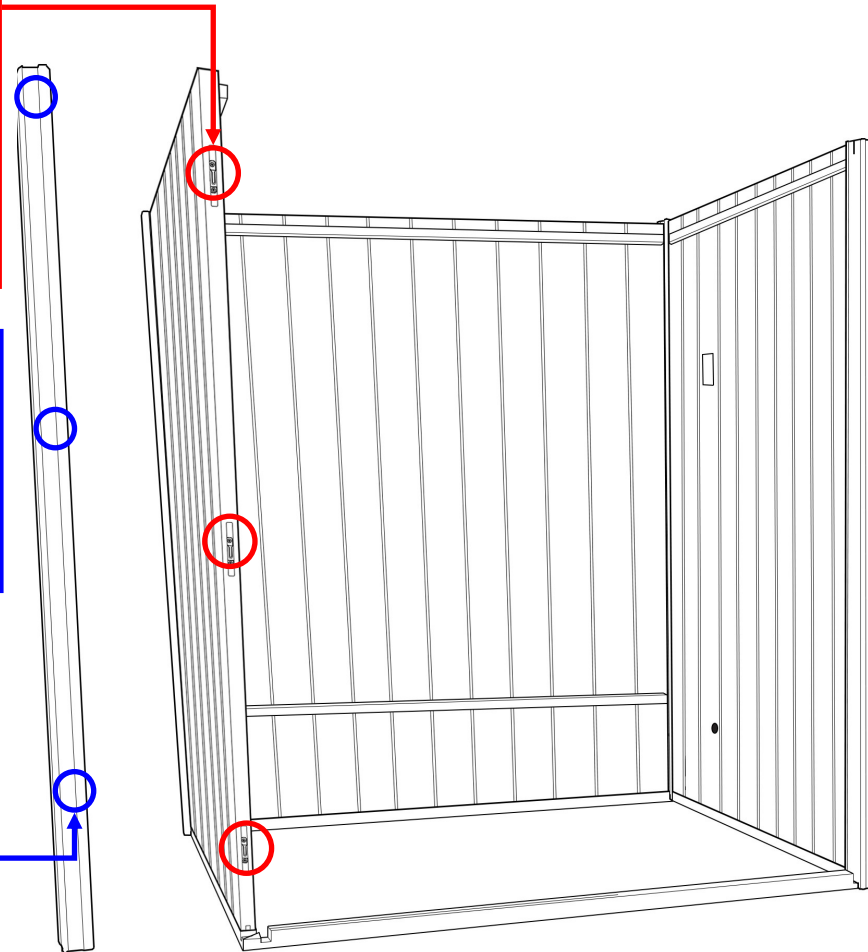
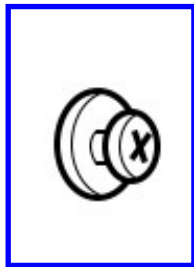

Step 10 — Electric box

The electrical box (below) should be housed in the sauna, underneath the back bench on the floor. Install electrical connections. Partner up all corresponding wires which are denoted by matching stickers from the box to the back/right panels.

The electrical box should be placed with the items facing down and the lid facing up.

Note: It is recommended to make this connection now with full access.

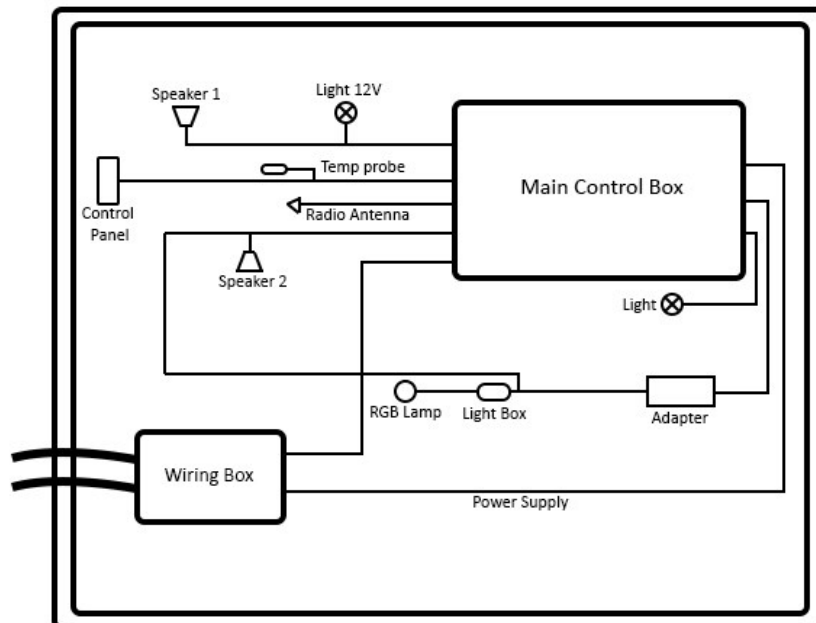
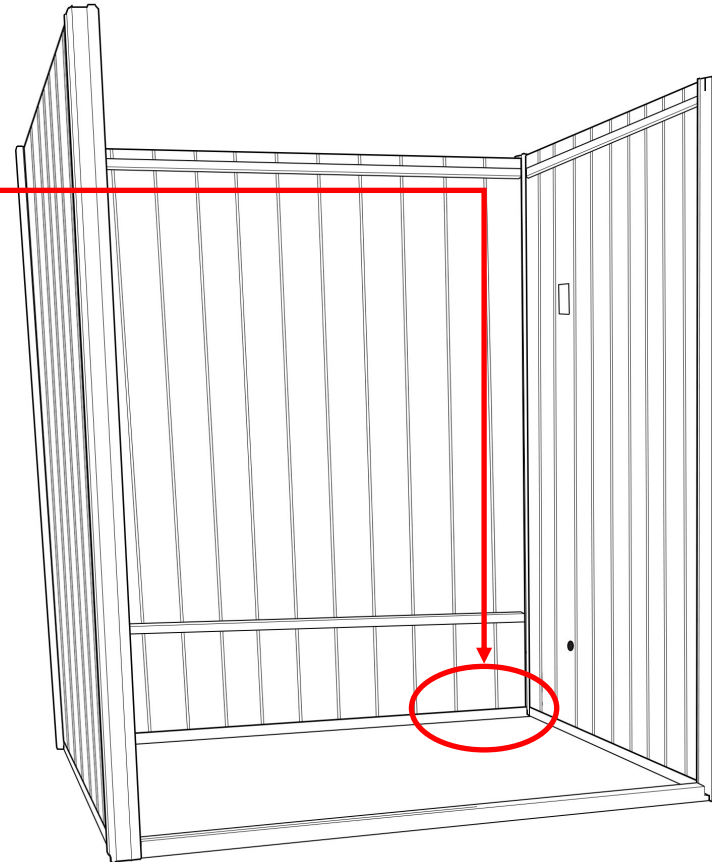

Step 19 — Installing the top frame

Locate the top framework into position. Secure loosely, as you need manoeuvrability of the framework to insert the fixed glass panel.

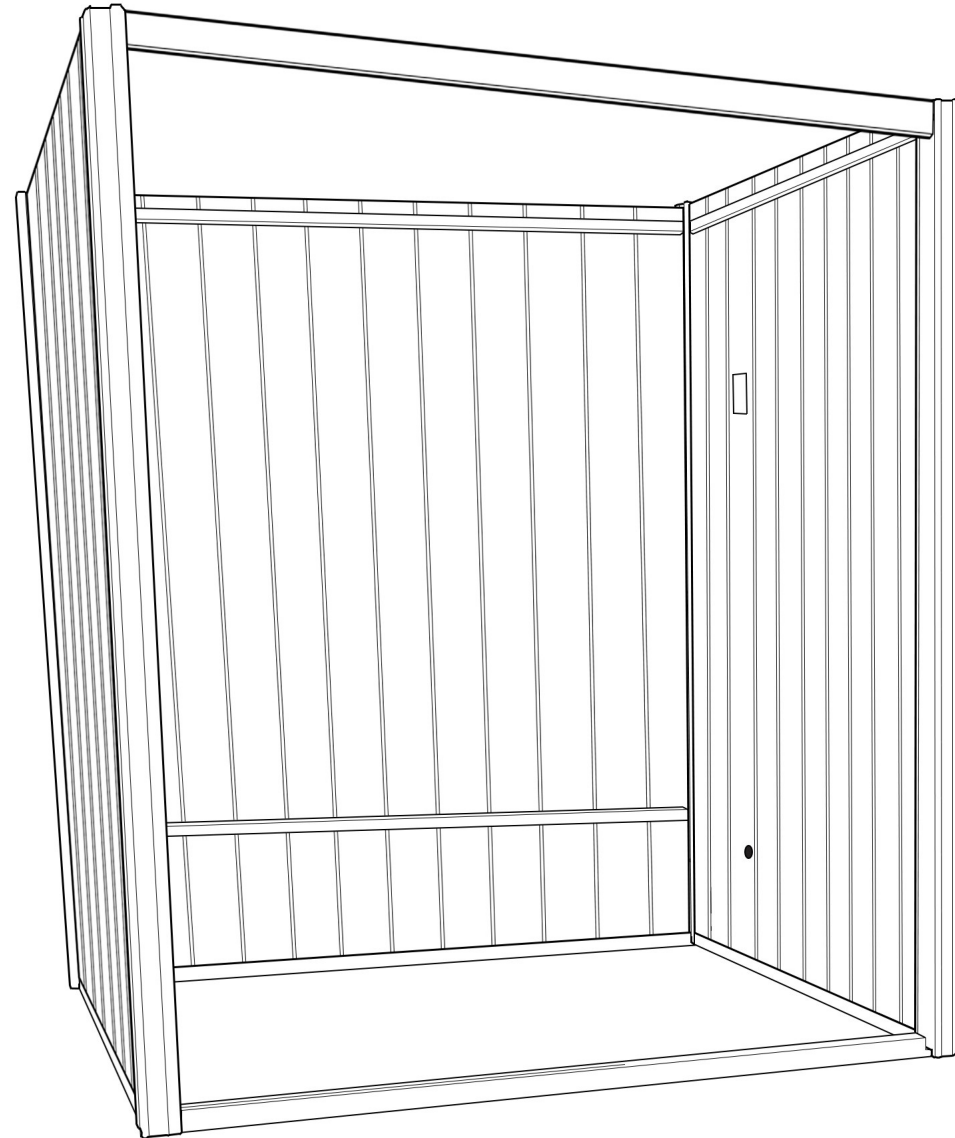
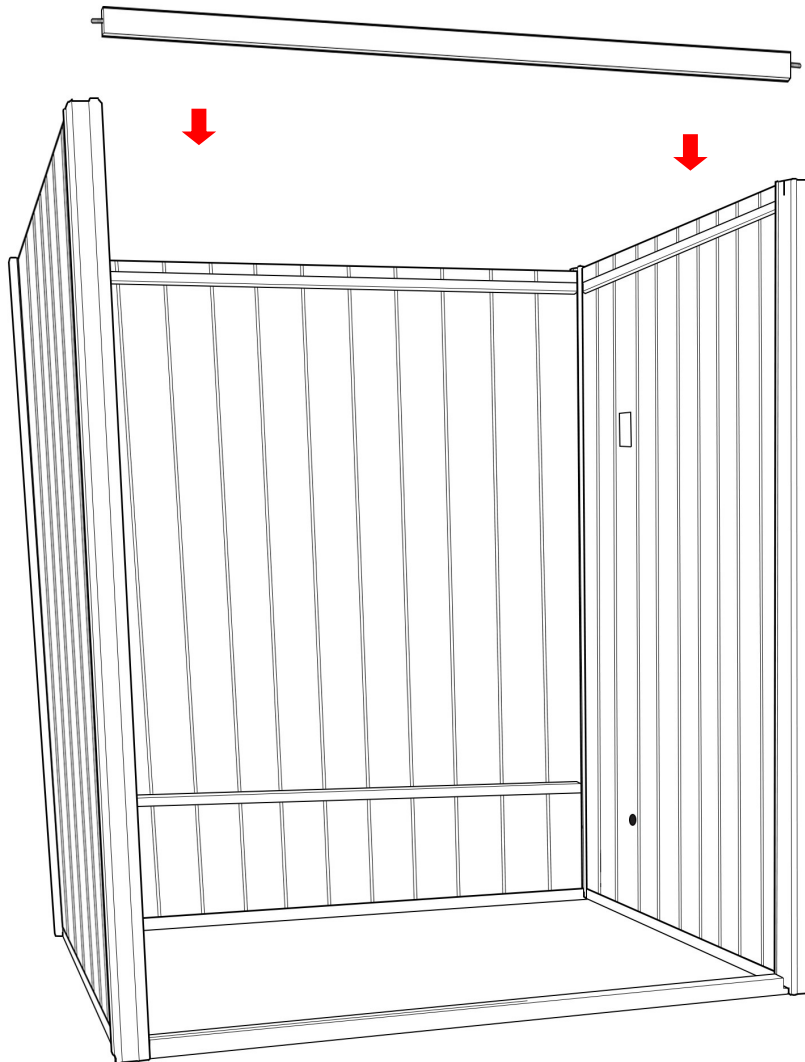

Step 11 — Placing the floor in position

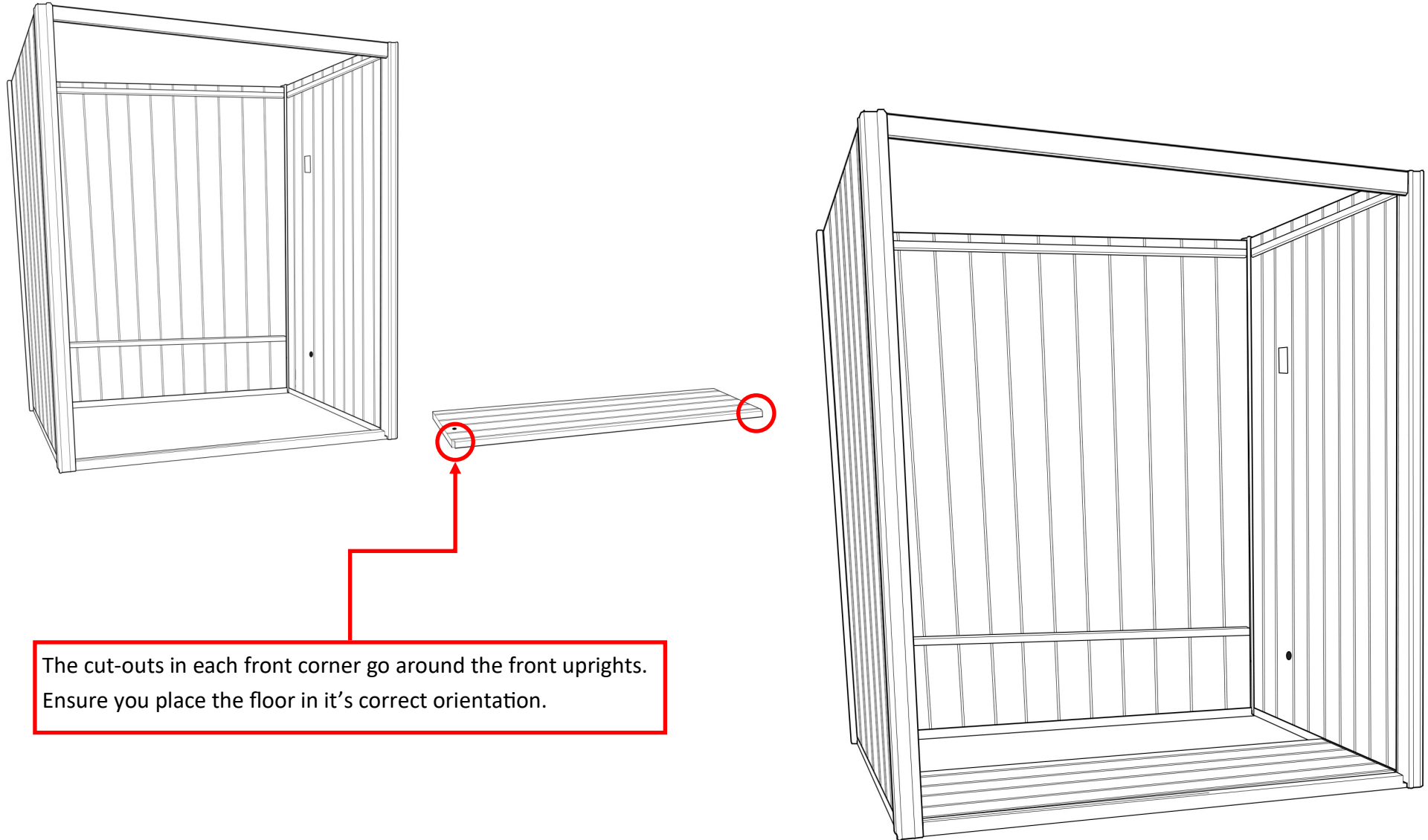

The cut-outs in each front corner go around the front uprights. Ensure you place the floor in it's correct orientation.

Step 13 — Placing the front of the bench

Place the front of the bench tight up to the floor.

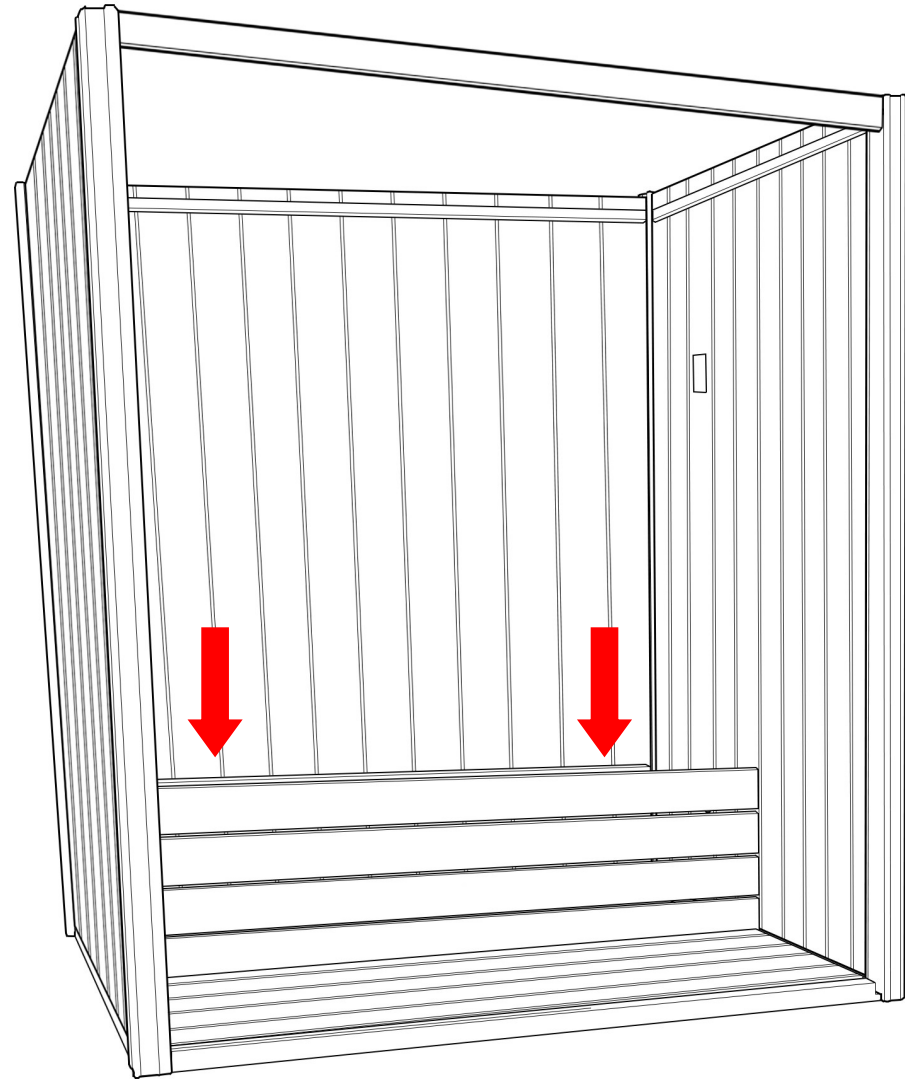
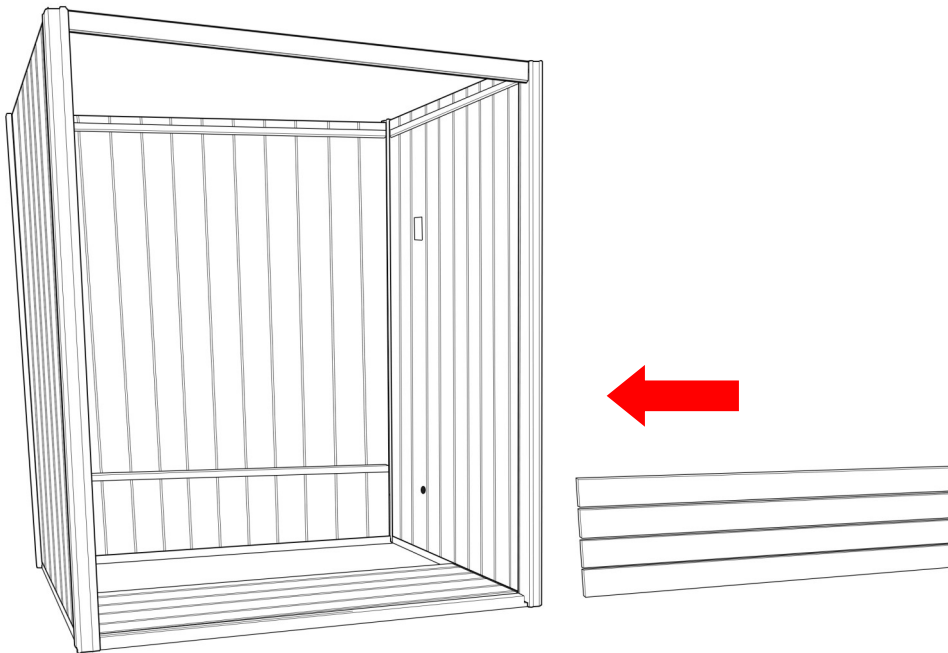

Step 17 — Placing under seat support frame

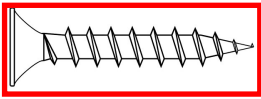

ST40 x 26

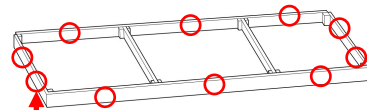
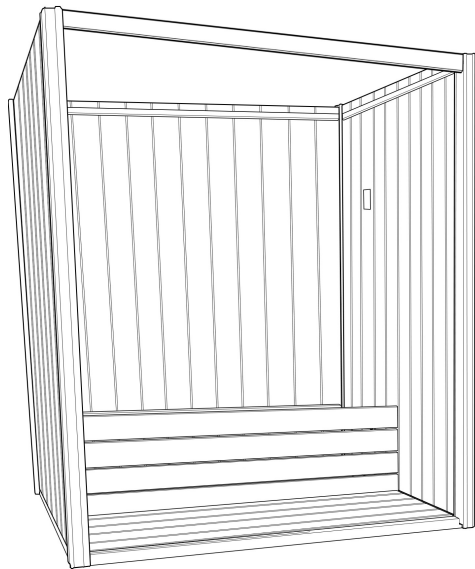

- Using ST40 Screws locate the large frame support to the back of the sauna.
- From the inside screw the base of all bench front to the adjoining panels.

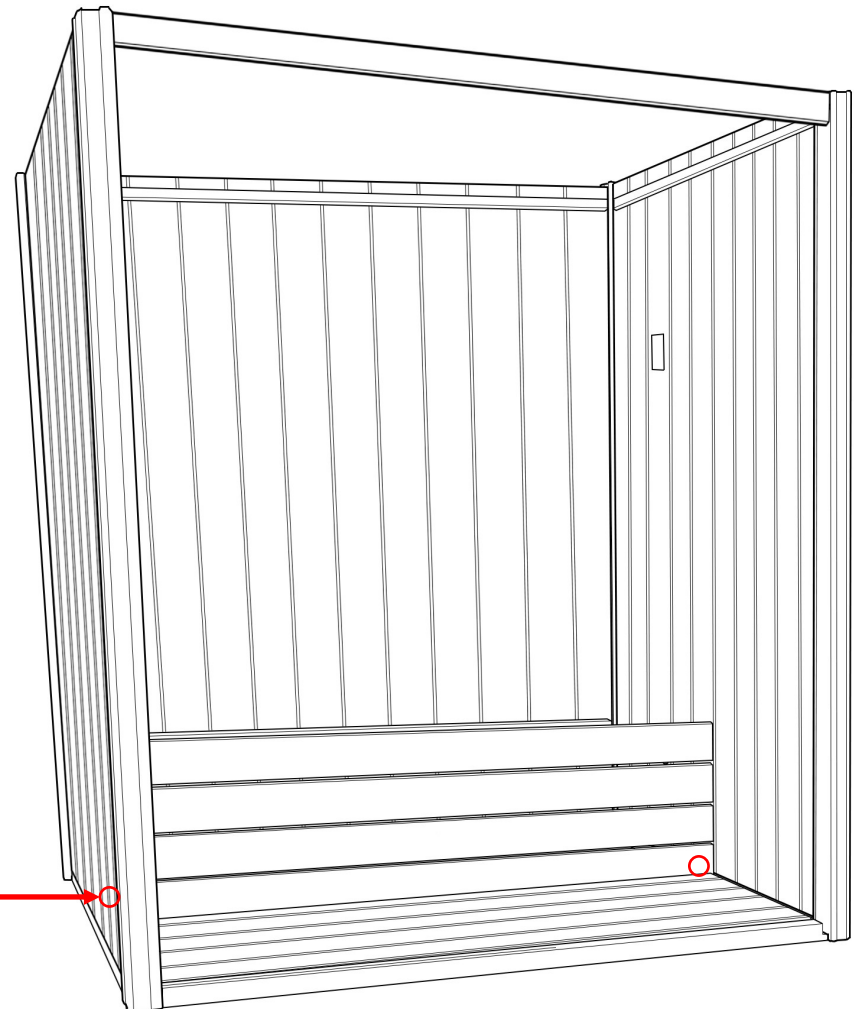

Step 18 — Placing the bench seat in position

Locate the bench seat into position by placing it onto the under support frame.

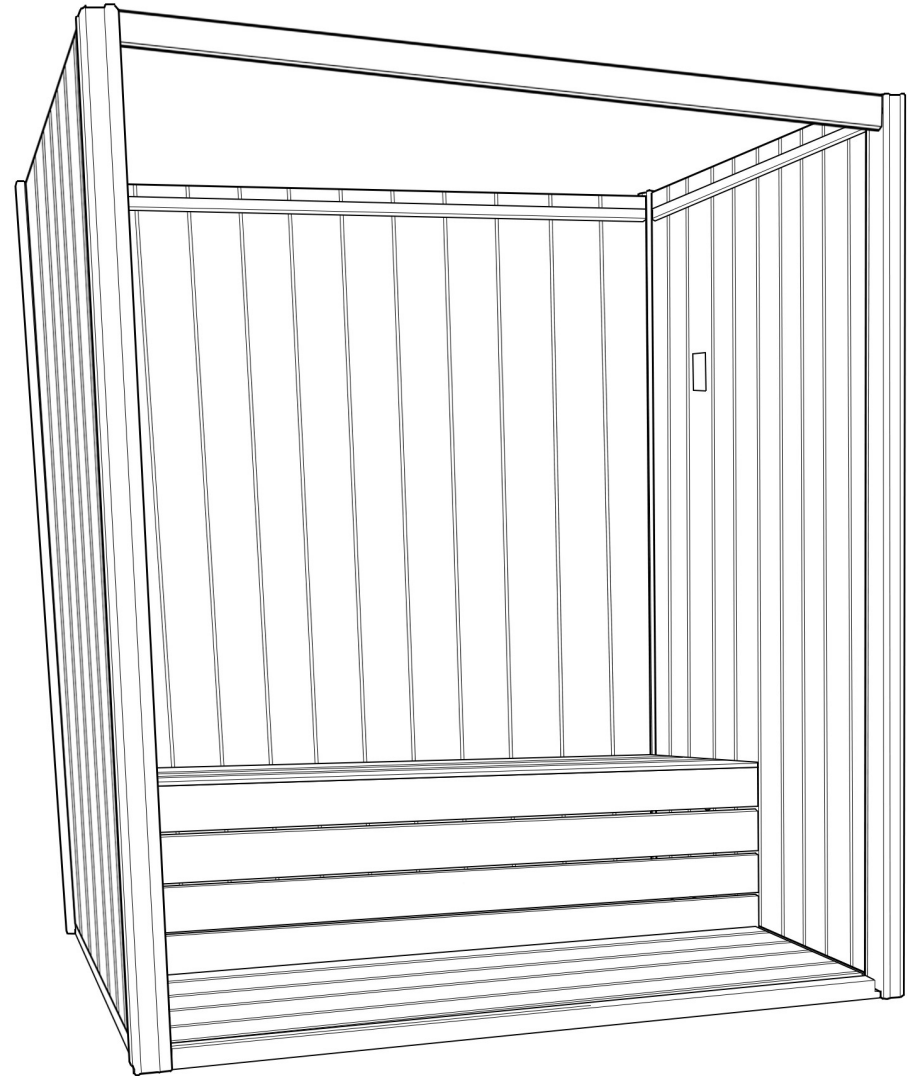
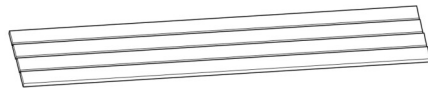
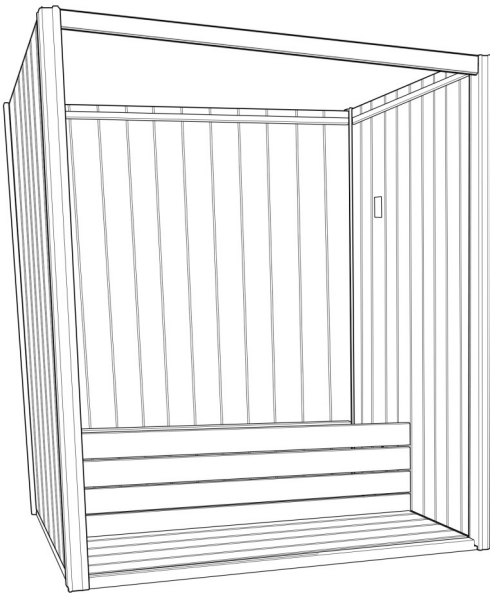

Step 18 — Installing the back rests

Locate the back rest and place along the back wall of the sauna.
Align using a spirit level and screw I in position using ST50 Screws.

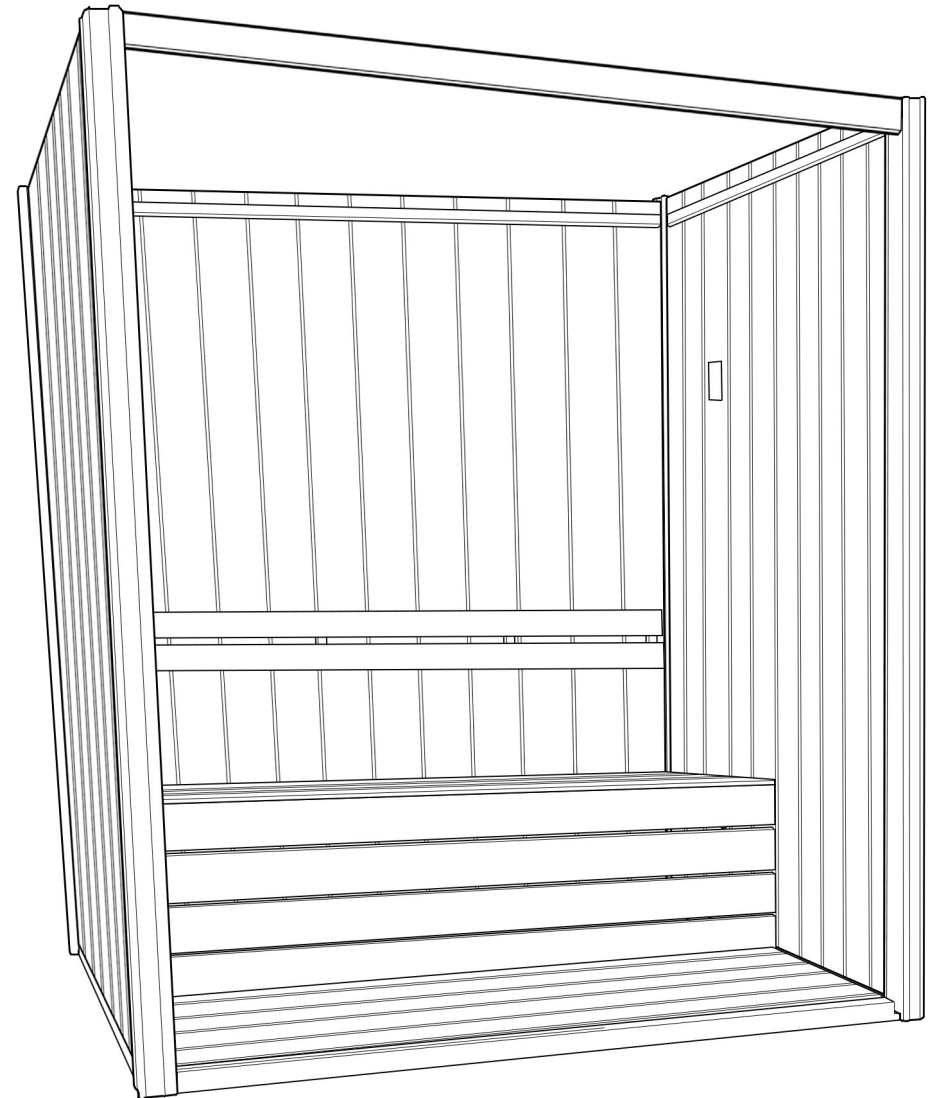
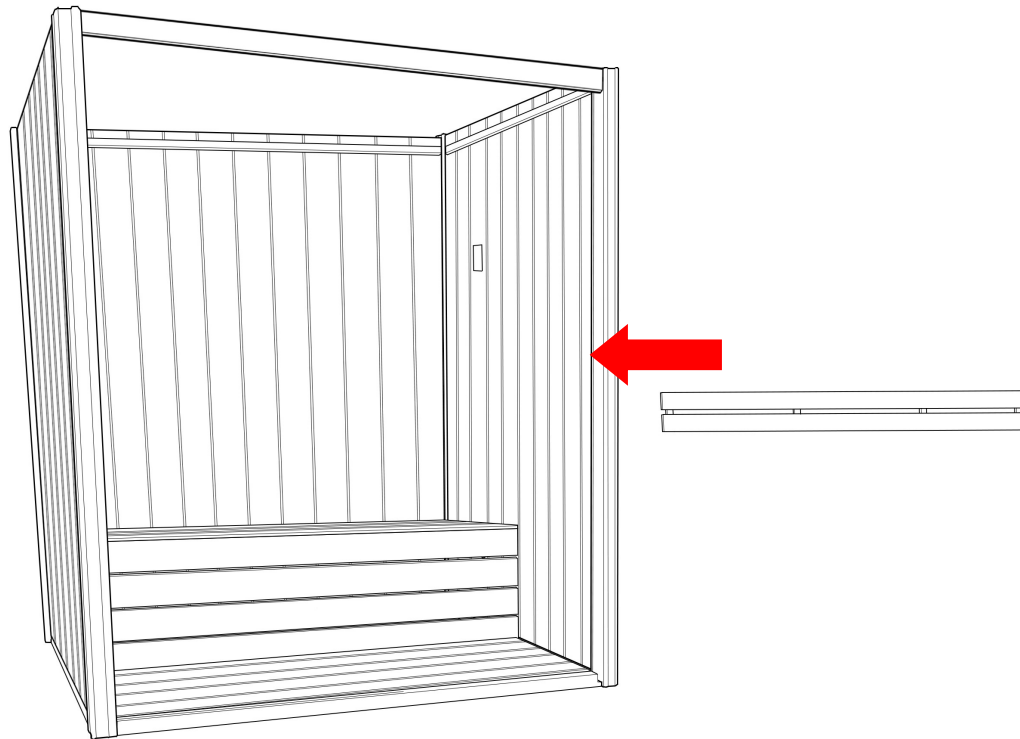

Step 20 — Installing the fixed glass panel

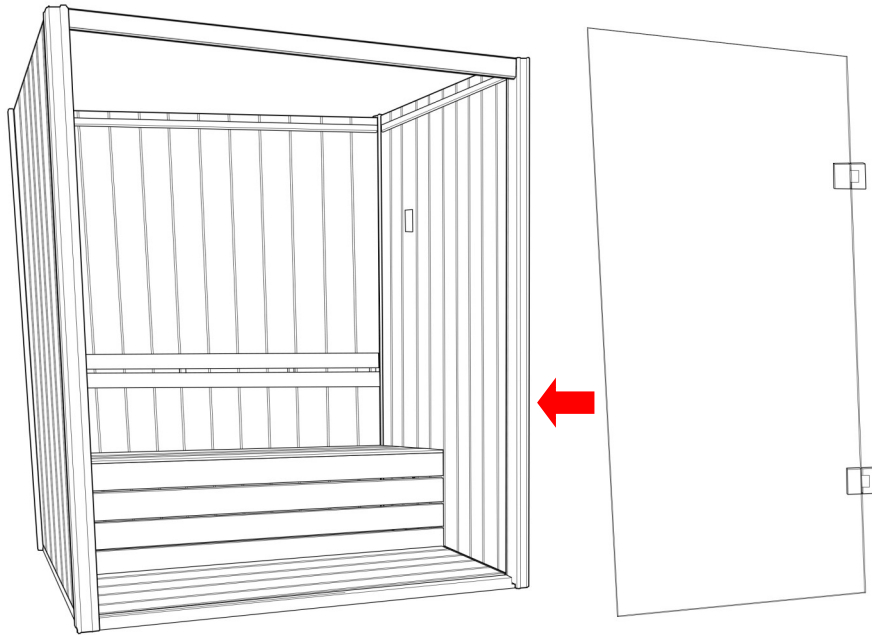

Insert the fixed glass into the groove cut-outs in the framework, lift the top framework up, then slot back down once it is in position.

Overhead view (right)

With the framework in position tighten the nut and washer from above.

Note: Be careful not to drop the hex nut and washer down the upright.

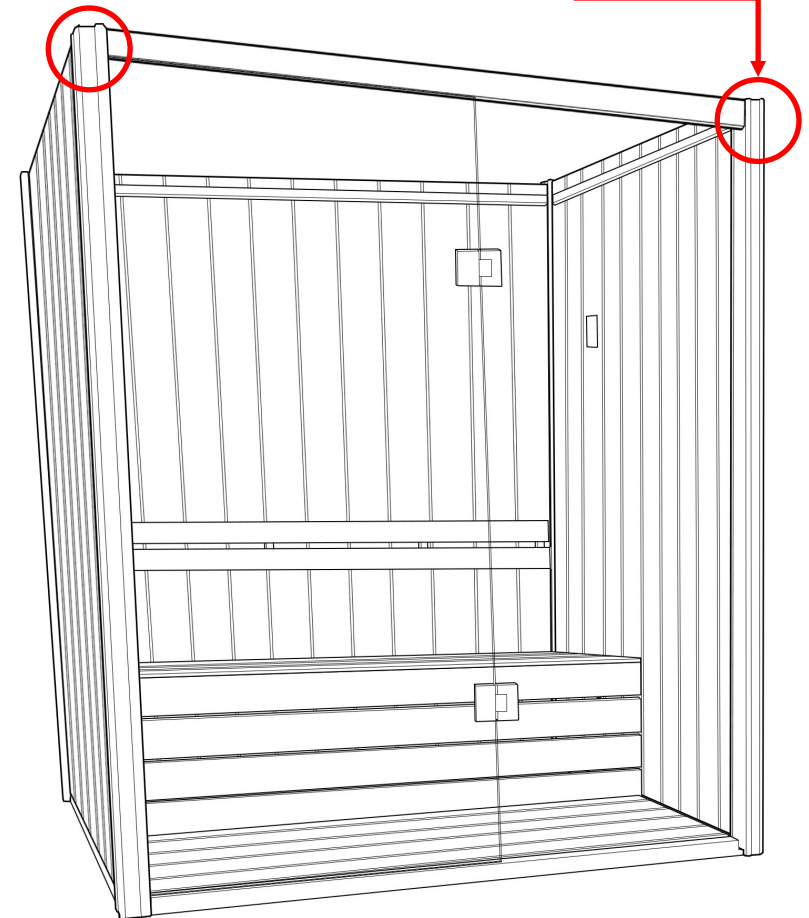
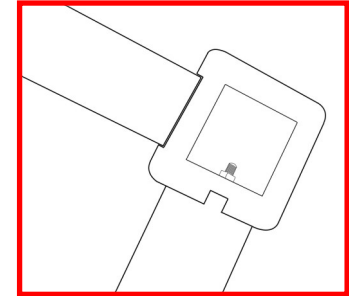

Step 21 — Installing the inner roof

Locate the inner roof and lift into position. Once in position, take all cabling from the back and side panel and connect on top of the inner roof.

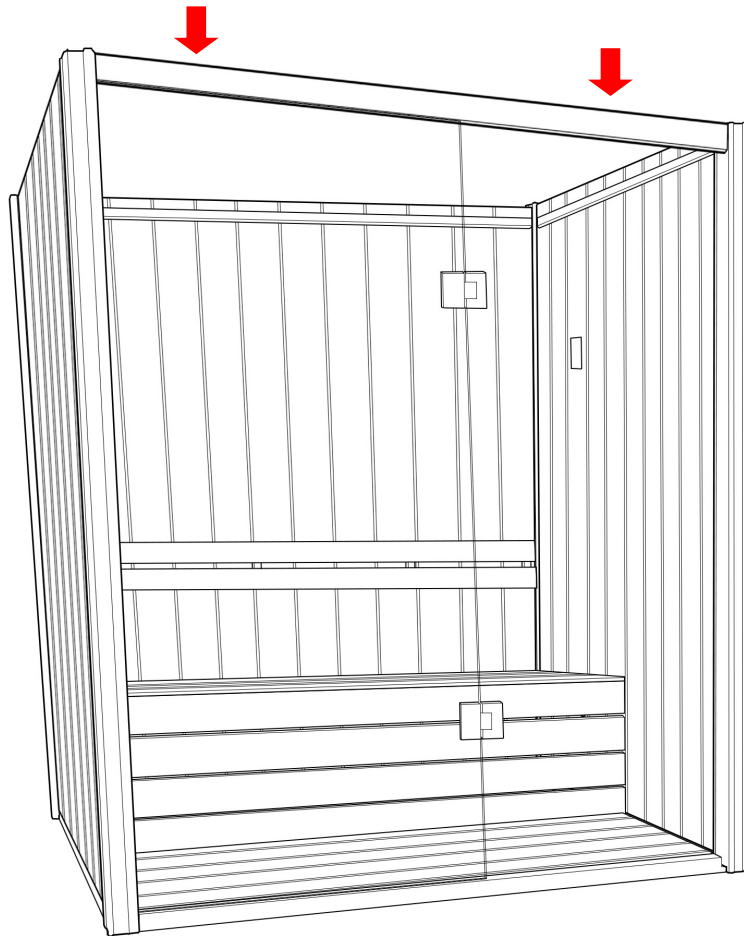
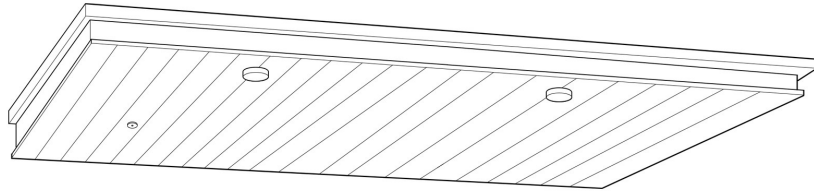

Locate the thermos probe and feed through the inner roof. Secure in position using silicone from above.

Ensure the probe extends approximately 75% out.

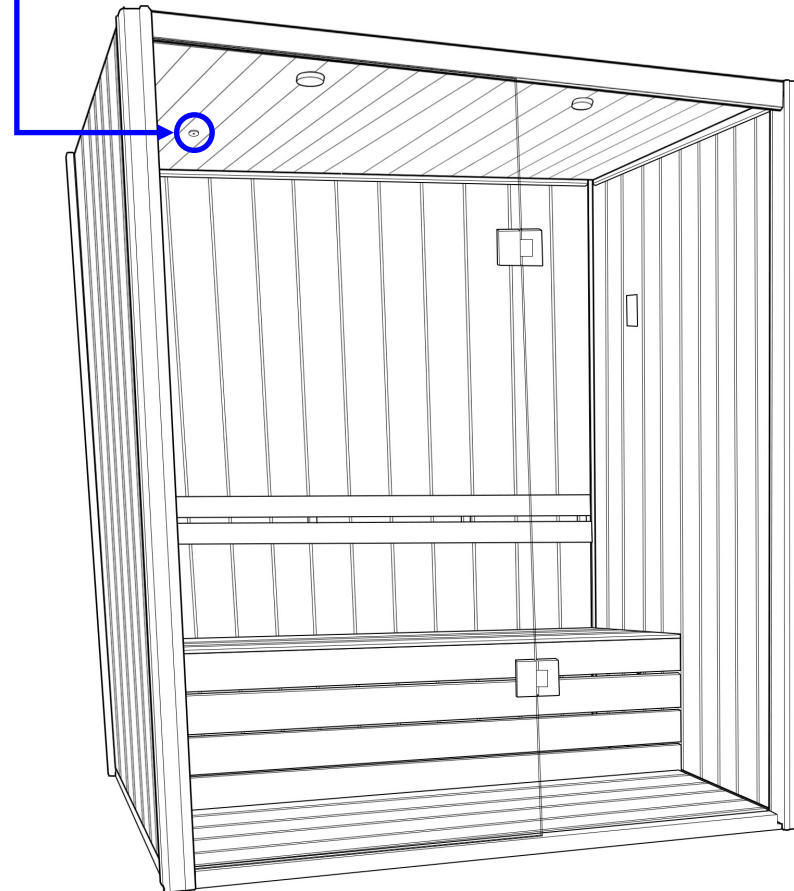
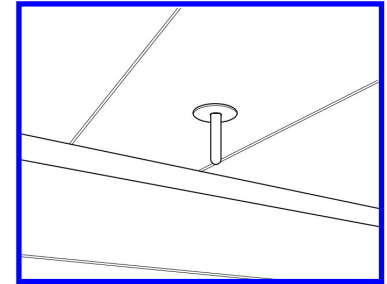

Step 22 — Installing the big roof

Lift the roof into position and position the square locaters into the top of all uprights.

Caution: Roof is heavy, Minimum 2 person lift advised.

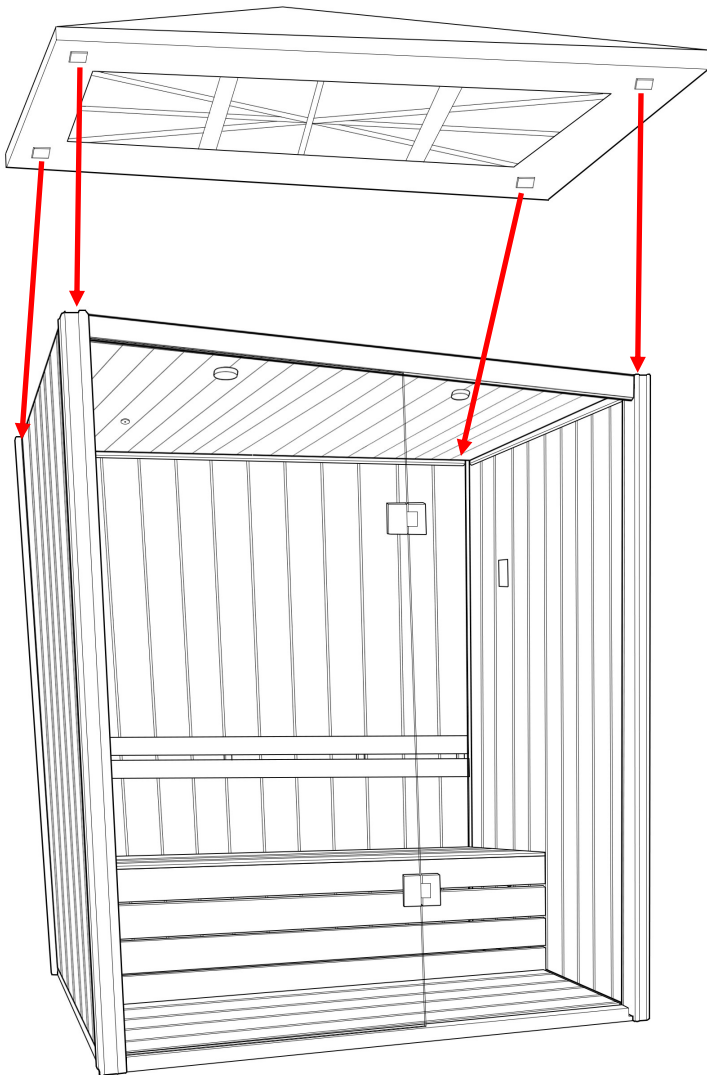

Step 22 — Installing the heater and heater guard

Locate the heater backplate and screw into position using the screws provided in the heater box.

Connect the heater hood by clipping it into the heater. Take the heater and locate it onto the backplate, resting the bottom within the grooves and securing it in position with a screw through a pre-made hole in the hood.

Take the heater guard frame and place it around the heater and screw into position using ST60 Screws.

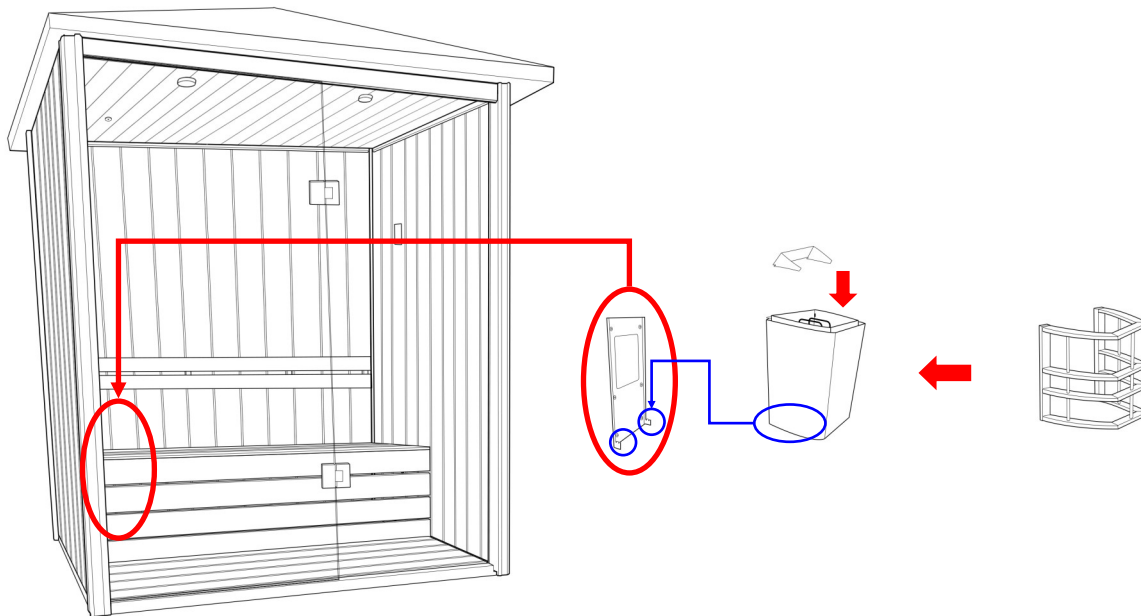

Step 22 — Installing the door handle

Locate the door handle and separate before attaching it to the door. The metal handle is designed to be on the outside of the sauna.

The door will be positioned here.

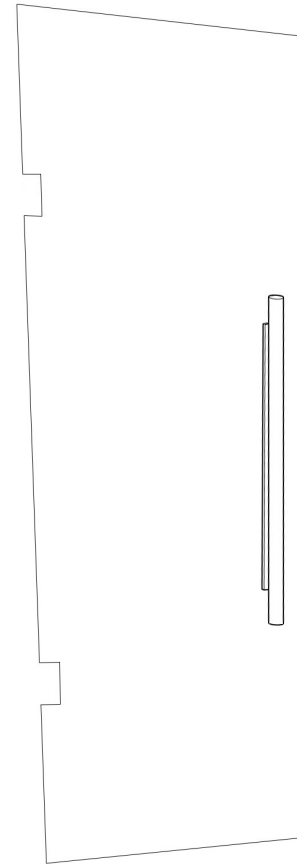
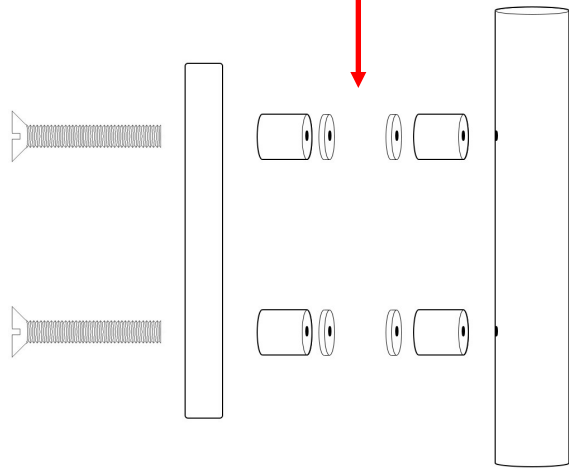

Step 23 — Installing the door

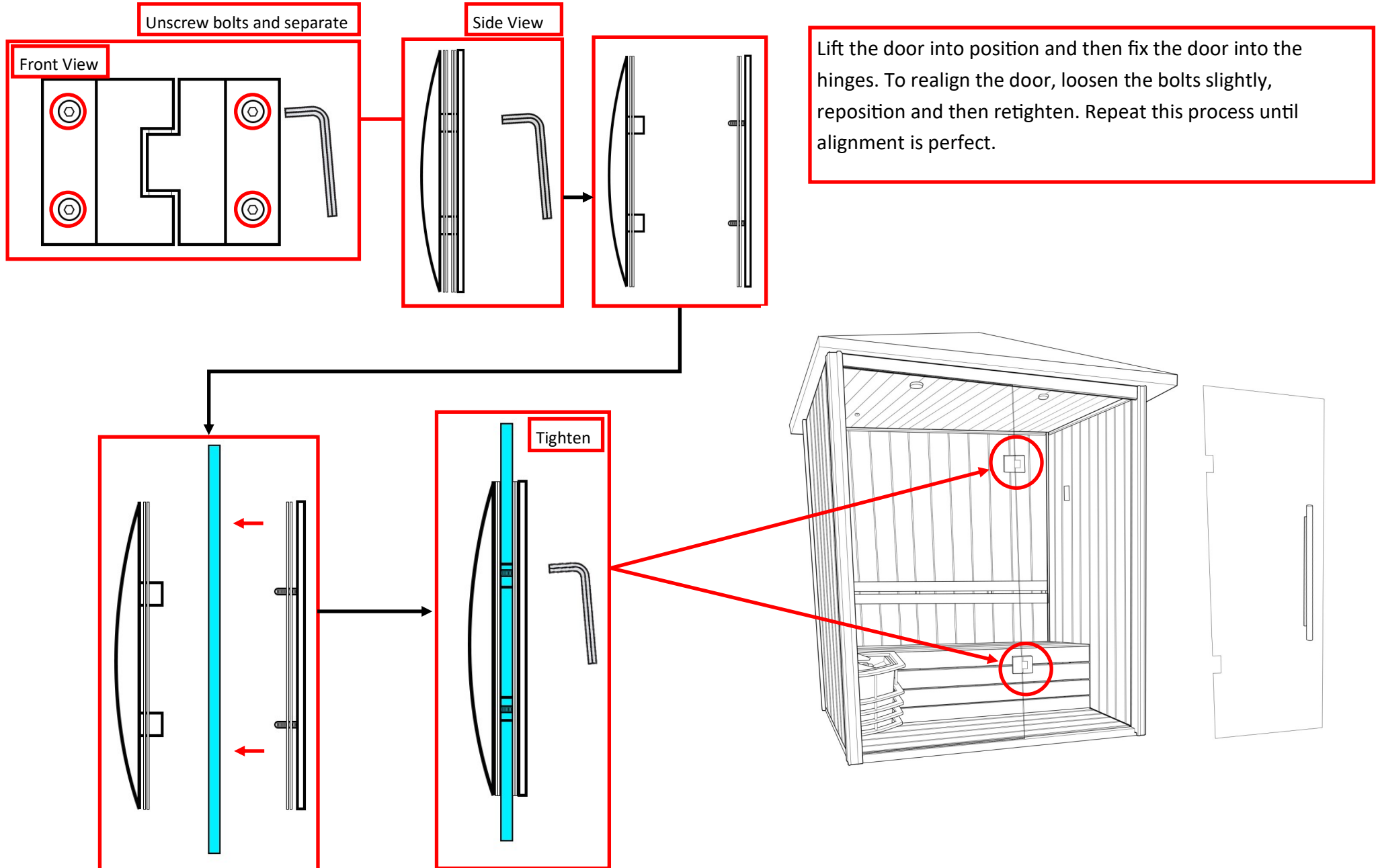

Step 25 — Accessories Installation

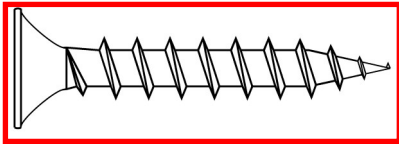

40mm Screws

Connect the light from the wire fed through the pre drilled hole in the back panel. Screw into position.

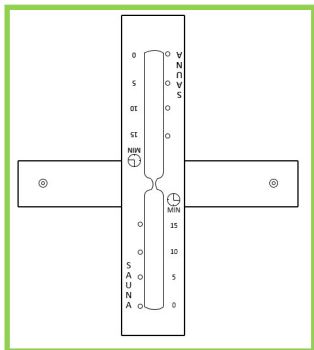
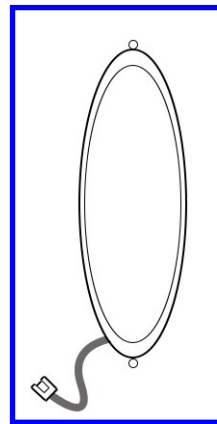

Use two screws through the backplate and position anywhere within the Sauna.

Place a screw into the back wall and hang the hygrometer.

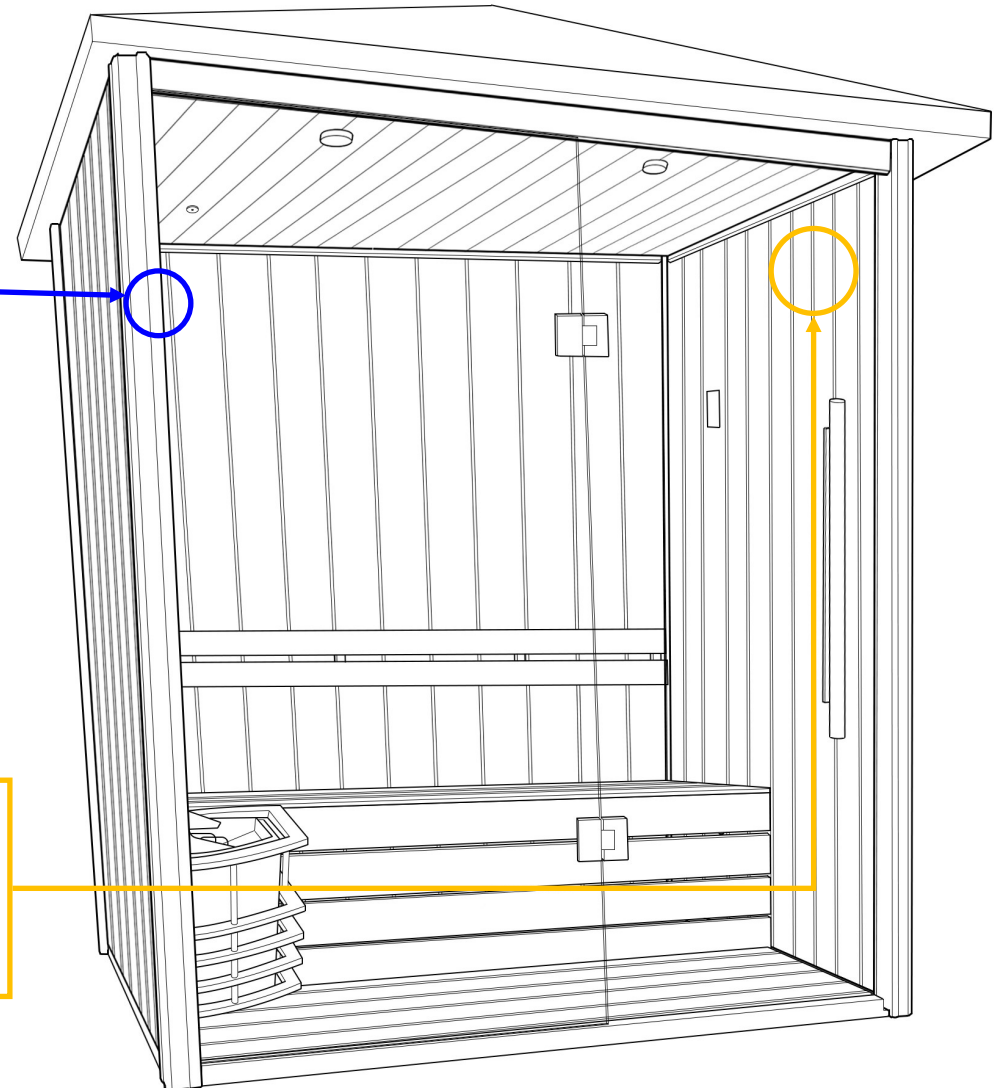
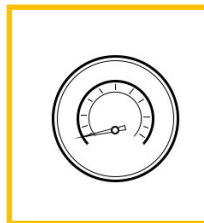

Control Panel Instructions

Button 1 (Lights)

Turn the 12V light on or off.

Button 2 (Return)







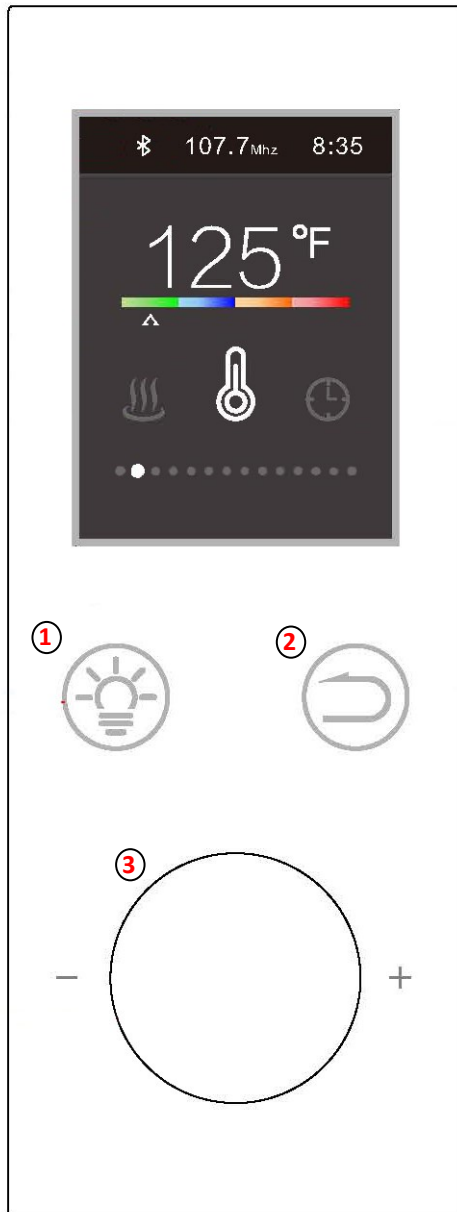

Press to return to the menu after a change is made.

Button 3 (Mode button/Scroll)

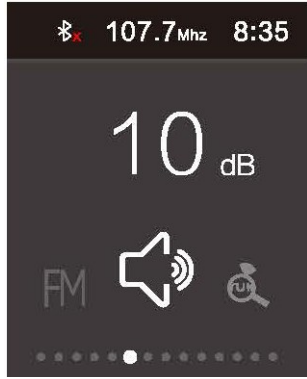
Press and hold for 3 seconds to power the panel on or off.

Press to change the control panel function, then scroll left or right to change settings. The panel automatically locks after 1 minute of inactivity. Press this button to unlock the panel.



<p style="text-align: center;">Coloured Lights</p>  <p>To operate the lights, press (Button 3) until you see the interface (left). Once here press (Button 3) and scroll through the light options.</p>	<p style="text-align: center;">FM Radio</p>  <p>To operate the FM Radio, Scroll (Button 3) until you see the interface (left). Once here, press (Button 3) to begin playing.</p>	<p style="text-align: center;">Volume</p>  <p>Scroll (Button 3) until you see the interface (left). Once here, press (Button 3) to enter the volume mode. Scroll up or down to change the volume.</p>
<p style="text-align: center;">Bluetooth Connectivity</p>  <p>To operate the Bluetooth, scroll with (Button 3) until you see the interface (left). Scan for the control panel on your device and pair. Once paired you should hear a connection tone. Press play on your device to begin listening.</p>	<p style="text-align: center;">FM Radio Station Search</p>  <p>Scroll (Button 3) until you see the interface (left). Once here, press (Button 3) and scroll to search through until it finds a station. Press again to continue searching.</p>	<p style="text-align: center;">Sauna Setting</p>  <p>Scroll (Button 3) until you see the interface (left). Once here, press (Button 3) to enter the sauna mode. This will toggle the Sauna heater on/off as desired. Use the Time/Temp settings to make the most out of your session.</p>
<p style="text-align: center;">Bluetooth Track Change</p>  <p>To change track whilst in the sauna form the panel, scroll to the audio interface (left). Then press the scroll (Button 3) and it will change to the next track. This will also change through the saved radio station list you have made. You can only skip forwards, not backwards.</p>	<p style="text-align: center;">FM Radio Station Save</p>  <p>Scroll (Button 3) until you see the interface (left). Once here, press (Button 3) and it will save the current radio station you are listening to. You can save up to 10 stations on this device.</p>	<p style="text-align: center;">12V Light Interface</p>  <p>Scroll (Button 3) until you see the interface (left). Once here, press (Button 3) to turn off the 12V light. Press again to turn it on. The light will turn on automatically when the panel is turned on.</p>

Settings

107.7Mhz 8:35

125°F



Scroll (Button 3) until you see the interface (left). Once here, press (Button 3) to enter the settings mode. Here you can set the clock which operates on a 24 hour system.

You can also change the temperature display to Celsius or Fahrenheit. Change either by entering the setting using (Button 3) and then scroll to change. Press (Button 3) again to confirm selection.

Time/Temp Setting

107.7Mhz 8:35

Temp setting

125°F



For temperature: Scroll (Button 3) until you see the interface (left). Once here, press (Button 3) to enter the temp mode. Scroll until desired temperature and simply press (Button 3) to confirm.

107.7Mhz 8:35

Timing

12:38
min



For time: Scroll (Button 3) until you see the interface (left). Once here, press (Button 3) to enter the time mode. Scroll until desired duration is set and simply press (Button 3) to confirm.

BEFORE FIRST USE — IMPORTANT

1. Ensure the rocks have been thoroughly washed before loading in to the heater.
2. Ensure you place the rocks loosely between the heating elements.
3. Don't over fill the heater, ensure sufficient airflow can be achieved for maximum output.
4. **START UP!** It's recommended that you heat the rocks thoroughly and leave the sauna door closed for a period of 20-25 minutes. The rocks being new may split or spit under the heat as they settle in. This is normal, but we recommend you don't sit in the cabin until you have run the heat through the rocks and they have settled in. You may want to turn the heater off and perform this a second time (when the rocks have cooled down) to be 100% certain they have settled in.
5. It's recommended that the rocks are replaced annually and only use approved Sauna rocks, **NEVER** use any other type of rock.
6. Never touch the rocks when they are fully heated.
7. Pour a ladle of water over the rocks approx. every 5 minutes to increase the air temperature.
8. Pouring too much water on the rocks will lower the room temperature as they will cause the rocks to cool down.
9. Never leave the Sauna unattended.
10. Children should not use the Sauna unsupervised.

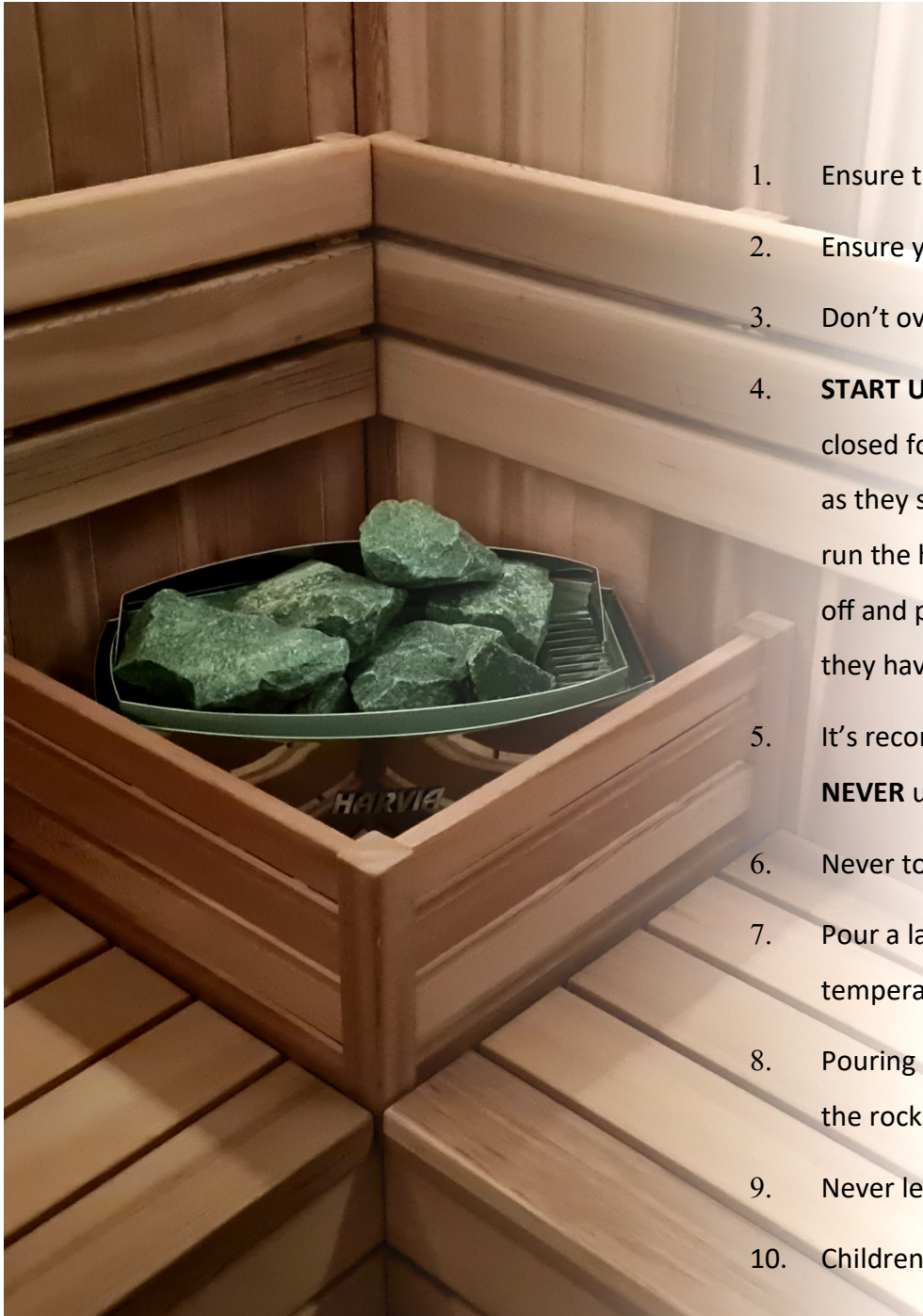

Sauna Usage & Safety Guide

1. When turning the heating stove on, you MUST pour water over the rocks as it's the vapour that creates the heat not the rocks. The rocks alone will never heat up the sauna. Failure to do this could cause the rocks to split and break
2. Never leave children unattended in the Sauna.
3. Regulate (if preferred) the temperature of sauna before session - Pre-heat time 15-30 minutes (from room temperature 20o C) Do not allow your sauna to overheat during pre-heat or use. This can be undertaken in two ways.
Set your heating stove to a low thermostat level (right knob). Set the timer to approx. 15 to 30 mins (left knob NOTE graded in hours)
Failure to do so can result in warping of internal fittings caused through excessive heating/duration or lack of humidity.
4. Never leave unattended.
5. Suggested operational heat range: Stove—60o C-90o C.
6. Never touch the heater whilst in operation, possible burning may occur.
7. Recommended time of use is between 15 and 20 mins. We highly recommend working up in time to this, beginning with 5-minute sessions to get your body used to using a sauna.
8. Stay hydrated during each Sauna session.
9. Exit the sauna immediately if feeling, uncomfortable, dizzy, faint, short of breath or sleepy.
10. Do NOT use the sauna if you're pregnant, have a heart condition, have low or high blood pressure. If you're unsure consult your GP before use.
11. If you have any underlying health conditions which you feel could be aggravated by an increase in temperature, consult your GP before use.
12. If you begin to have any issues with your health after using a sauna, stop immediately and consult your GP regarding your symptoms before continuing to use.
13. Consult your GP before using the sauna room if you're on medication at all, especially with drowsy side effects.
14. Never use this sauna if you have been drinking alcohol or under the influence of other substances.
15. Do not put combustible material on the heaters at any time.

WEEE Compliance Statement

The UK Waste Electrical and Electronic Equipment (WEEE) regulations came into force on 2 January 2007. Under this new legislation, producers of electrical and electronic equipment (EEE) have to fulfil certain obligations.

Under the WEEE directive Insignia is considered the producer of certain products we supply and in line with the demands of the legislation we are pleased to offer the opportunity to return these products to us for treatment and recycling.

Insignia products will generally have an identifying mark and the common crossed out wheelie bin label. We accept returns of all products carrying the Insignia brand. All other products are either considered outside the scope of WEEE or Insignia is not technically the producer of these products. Insignia also accepts historic like-for-like WEEE returns. All WEEE returned to Insignia will be recycled in appropriate treatment and recycling centres in accordance with the legislation. If you wish to return any products to us, please send your item(s) to our head office.

Company Contract No. 326457

WEEE Producer No. CBDU64227

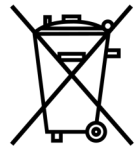

LABELLING

Products labelled with the WEEE symbol (a crossed out “waste bin”) indicate that the final user should not discard this product along with other household waste, but that it must be collected and treated separately.



Returns Address for WEEE

Insignia

9a Deans Road, Old Wolverton, Canon Industrial Park, Milton Keynes, Buckinghamshire, MK12 5NA, UK



EU – Declaration of Performance

Insignia declares that all its products complies with the essential requirements and other relevant provisions of Directive 305/2011/EC. A copy of the Declaration of performance is available from www.insigniashowers.com/ce-certification

Insignia™ is a registered trademark of Maclean International Ltd, 9a Deans Road, Old Wolverton, Canon Industrial Park, Milton Keynes, Buckinghamshire, MK12 5NA, UK

All images are subject to copyright. Images may not be used in any way shape or form with out written permission from Maclean International Ltd. Images are NOT permitted to be saved, printed or uploaded. Violation of copyright laws are punishable by law.

All images are registered with
ImageTraker

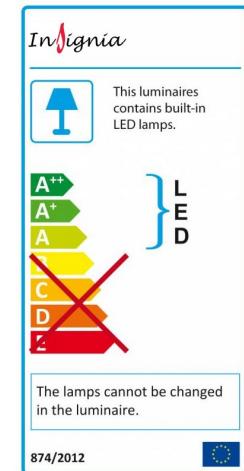

Insignia™ is a registered trademark of Maclean International Ltd

All images are subject to copyright. Images may not be used in any way shape or form with out written permission from Maclean International Ltd. Images are NOT permitted to be saved, printed or uploaded. Violation of copyright laws are punishable by law.