

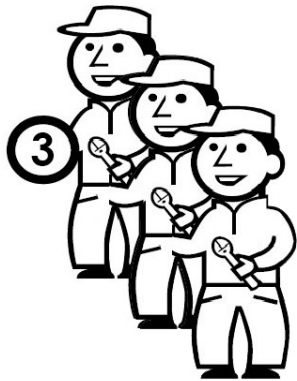

INSTALLATION MANUAL

MXOS1500

Outdoor Sauna Series



30 Day Technical Support:

Call **01908 317512** and request technical support for aiding your installation.

Replacements Parts: Inside of your warranty period visit:

<https://www.insigniashowers.com>, click support and make a warranty claim.

Spares/Replacements Parts: Outside of your warranty period visit

<https://www.insigniashowers.com/replacement-parts.html>

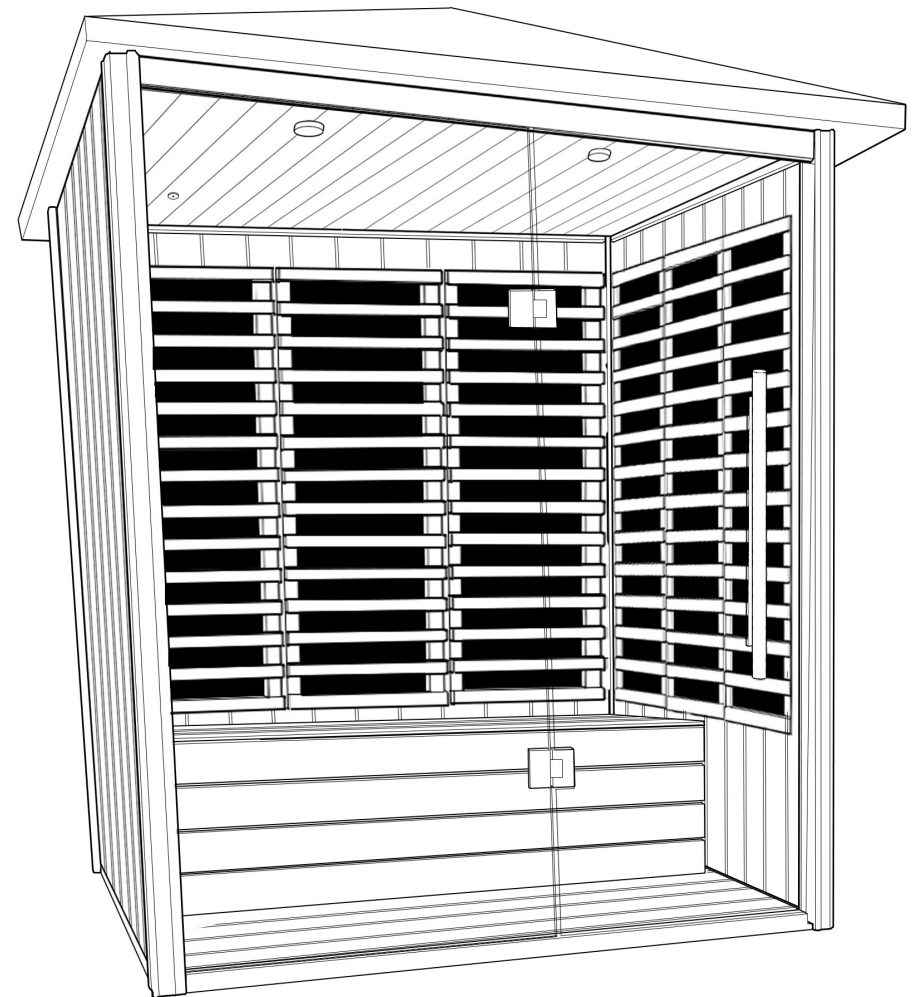

ATTENTION INSTALLERS:

These instructions must be left with the customer

CHECK ALL CONTENTS BEFORE BUILD COMMENCES. NO RETURNS CAN BE MADE ONCE THE BUILD HAS STARTED AS IT IS DEEMED ACCEPTANCE OF PRODUCT!

Contents

Thank you for your purchase	3
Electrical & Tool requirements	4
Box contents	5
Installation Instructions	6
Creating the base	7
Installing the back right upright	8
Installing the back panel	9
Installing the back left upright	10
Installing the right side panel	11
Installing the right front upright	12
Installing the left side panel	13
Installing the front left upright	14
Electric box install	15
Installing the top frame	16
Floor placement	17
Placing the bench front	18
Under seat support frame install	19

Bench seat install	20
Installing the fixed glass panel	21
Installing the inner roof	22
Installing the big roof	23
Installing the door handle	24
Installing the door	25
Installing the accessories	26
Control Panel Instructions/Operation	27
Sauna Room Safety Guide	30
WEEE Compliance Statement	31



Thank you for your recent purchase of an Insignia Sauna. Please read this booklet with great care to ensure you get the best out of your build and have a Sauna that will last for many years to come! Like everything, in order to obtain a first class product that will serve you well for many years, the effort and correctness put into the assembly will reflect in the quality of your finish.

IMPORTANT!

OUTDOOR SAUNAS

CHOOSE BUILD DAYS WITH LOW HUMIDITY / NO RAIN / WET WEATHER IN COMING DAYS.

ALWAYS WOOD TREAT EXTERNAL PANELLING WITHIN 24 HOURS OF COMPLETION.

(Failure to do so can cause panel warp)

Electrics

Tools Required

Infrared Heaters

8 x 330 watt (2800 watts total) 240 volt single phase connection

Other

LED lighting, radio, Bluetooth etc single phase 120 watts

Total rating 2800 watts

Amperage 10.45 amps

Always consult a qualified Electrician before connection as to suitability Your electrical contractor will understand ALL legal requirements of connection before undertaking any work or installation.

UNDER NO CIRCUMSTANCES UNDERTAKE THIS YOURSELF. ALWAYS USE AN ELECTRICAL CONTRACTOR AND ENSURE LEGAL CERTIFICATION IS GIVEN ON COMPLETION

The MXOS1500 has provision for 240 volts. Your qualified electrician will advise on the method they feel best suits your situation and electrical supply along with any potential benefit either may have.

- Scissors
- Knife
- Spirit Level
- Tape Measure
- Philips Screwdriver
- Electric Drill
- Safety Gloves
- Safety Glasses

What's in the Boxes?



Contents	Quantity	
Back Panel	1	[]
Left Panel	1	[]
Right Panel	1	[]
Fixed Glass	1	[]
Door	1	[]
Inner Roof	1	[]
Big Roof	1	[]



Contents	Quantity	
Light	1	[]
Door Handle	1	[]
Bench Top	4	[]
Bench Vertical Supports	4	[]
Under Bench Support	4	[]
Screw Pack	1	[]

VERY IMPORTANT

Have you got everything? If not please contact the Insignia directly on **01908 317 512**. Remember **NEVER** book your tradesman until everything has arrived, been checked and is present. No replacement/missing parts can be obtained free of charge during or after the build. Any claims can only be within the timescale permitted (48 hours after delivery) and always **BEFORE** build.

Installation Instructions

Please note : Must be installed on a solid and level base. Use bearers to allow gap to prevent damp transfer.

Maintenance Instructions

Please note : Like all timber products, such as garden sheds and fencing, garden saunas require full exterior wood weatherproofing treatment after installation to ensure long life and prevention of water ingress.

Step 1 — Creating the base

Create a square using the 4 bottom struts.

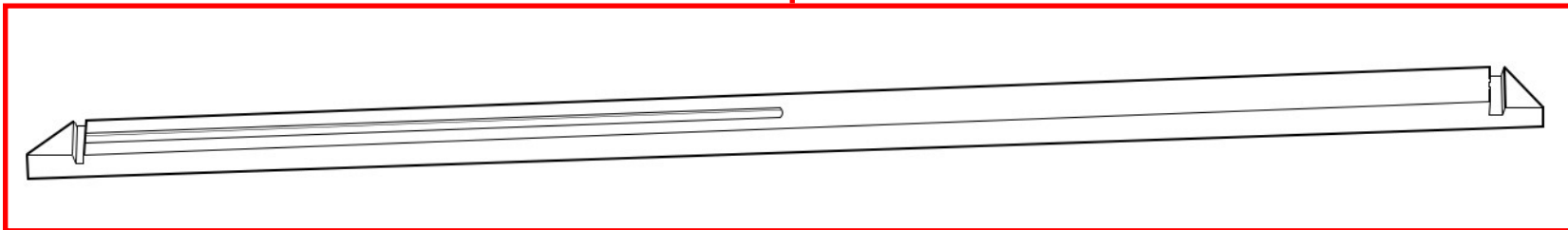
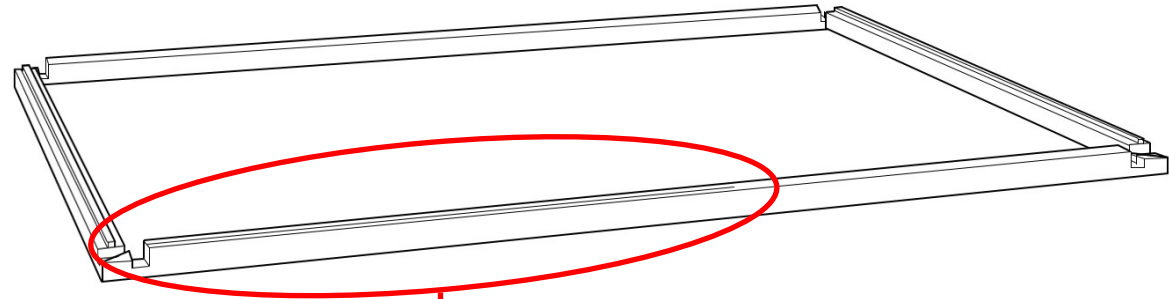

Note: The front strut has a groove cut out for the front fixed glass panel. Make sure this strut is at the front of the square.

Step 2 — Installing rear right upright



There will be 3 screw connections on two faces of the upright. They should face towards the back bottom strut and right bottom strut.

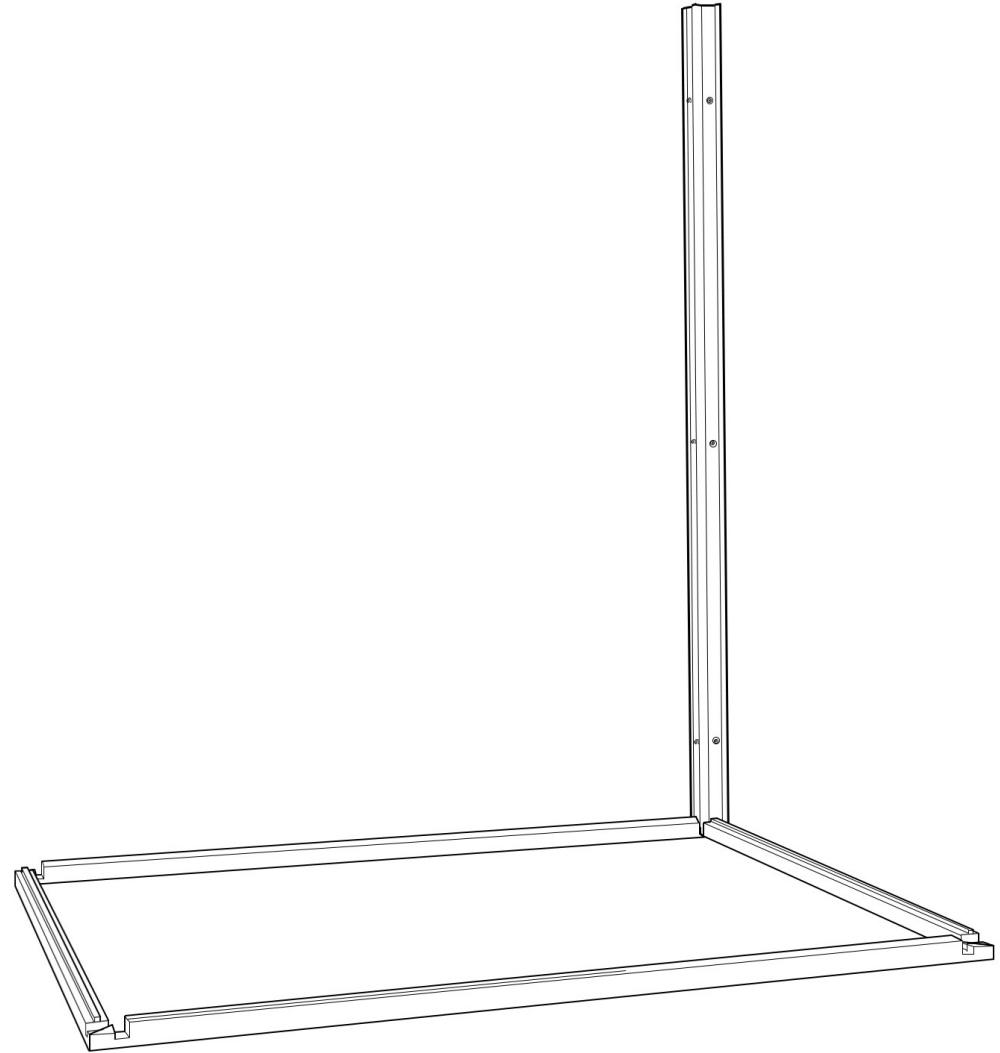
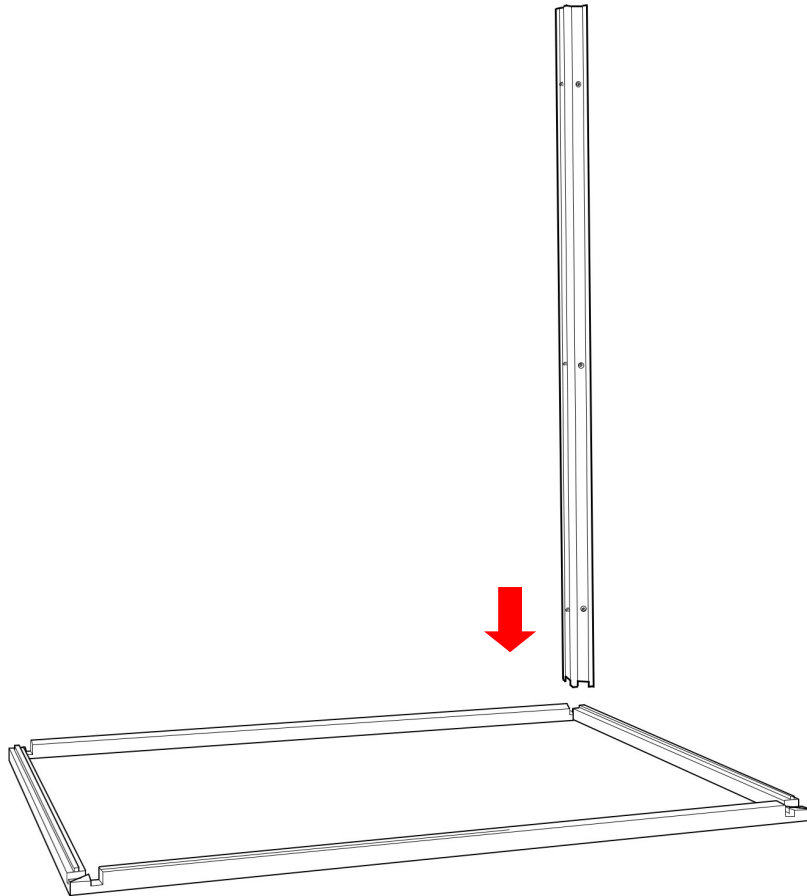

Step 3 — Installing the back panel

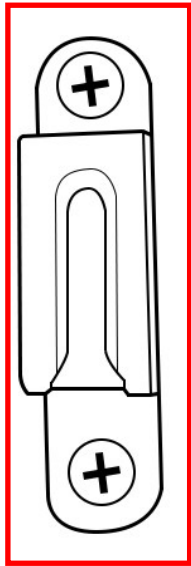

Lift the back panel and slide the brackets over the screw fixings and lock into position. Also ensure you push the panel down onto the back bottom strut and ensure they lock together.

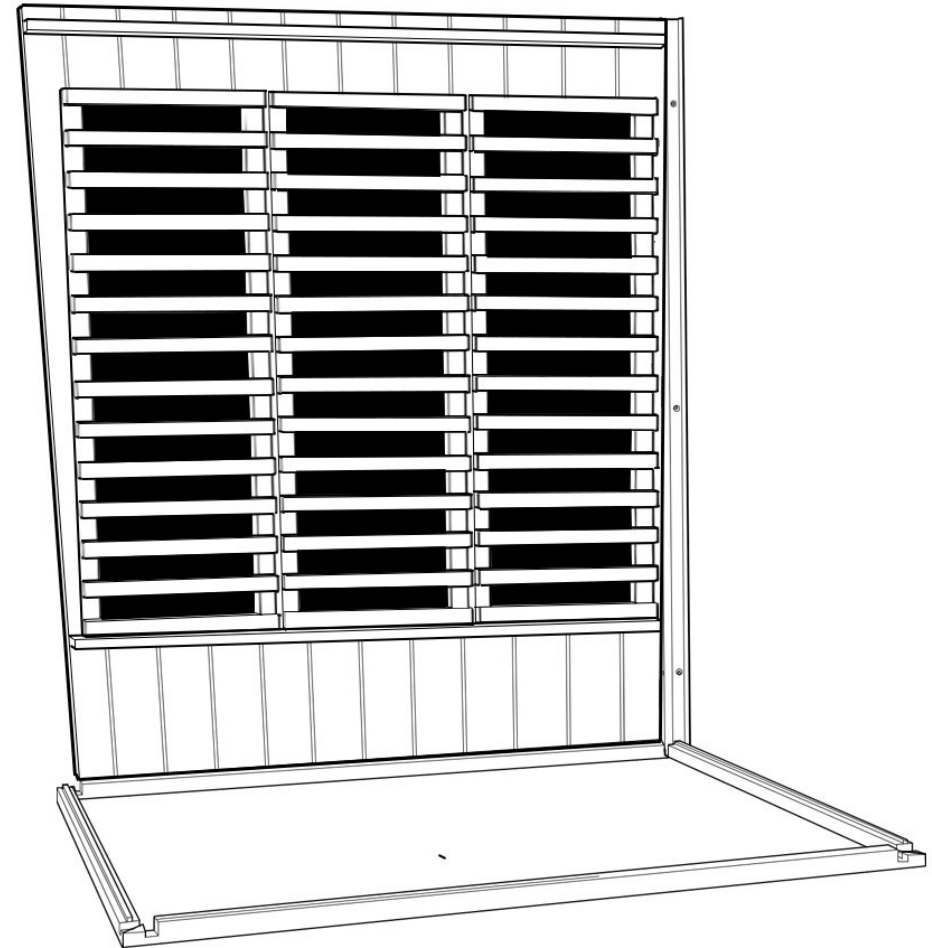
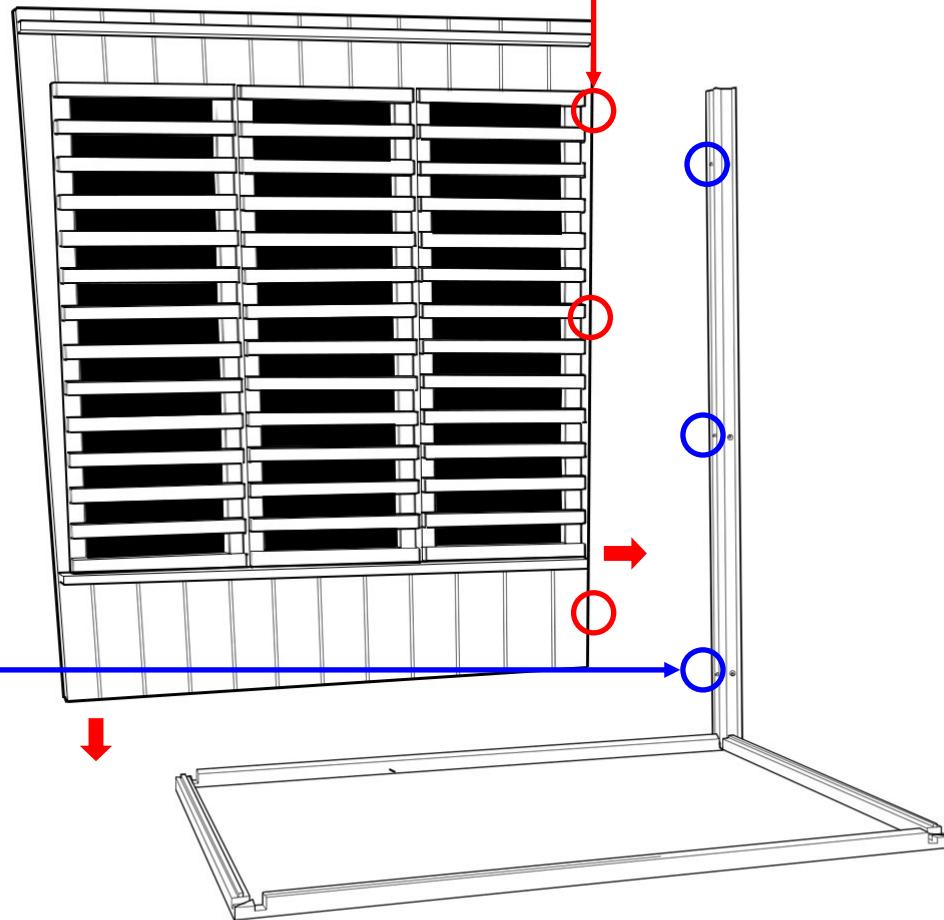

Step 4 — Installing the back left upright

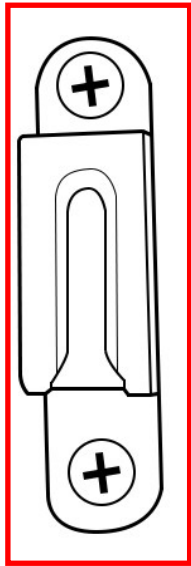

Tilt the back panel up in order to get the back left upright to slot into the brackets. Connect and push the right back upright down and secure into position.

There will be 3 screw connections on two faces of the upright. They should face towards the back bottom strut and left bottom strut.

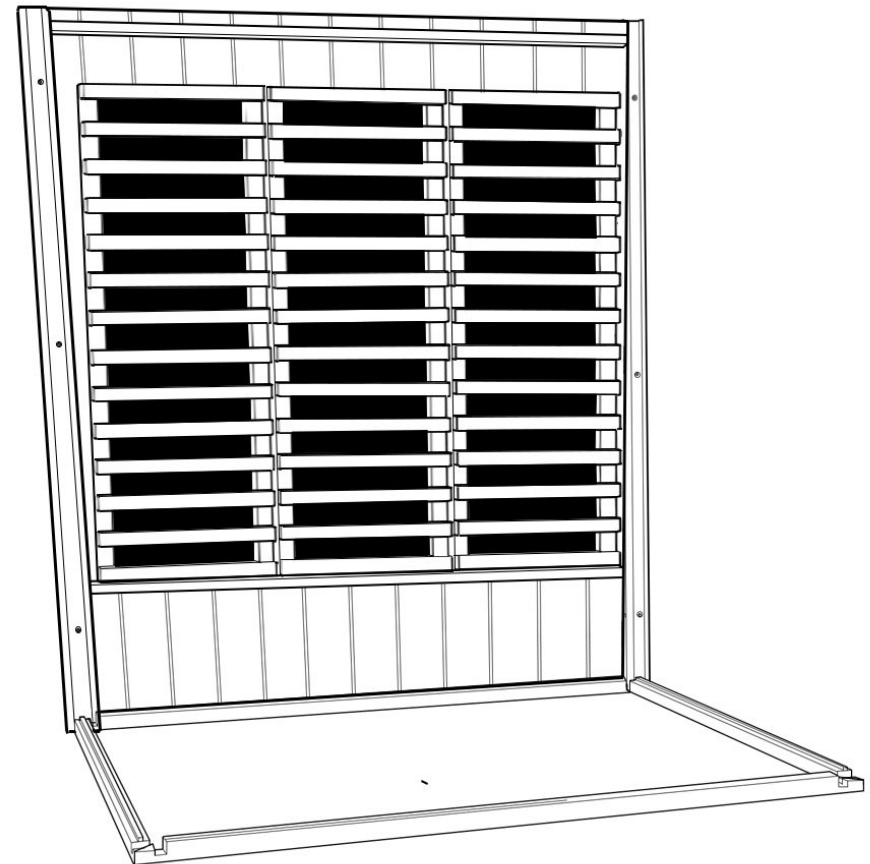
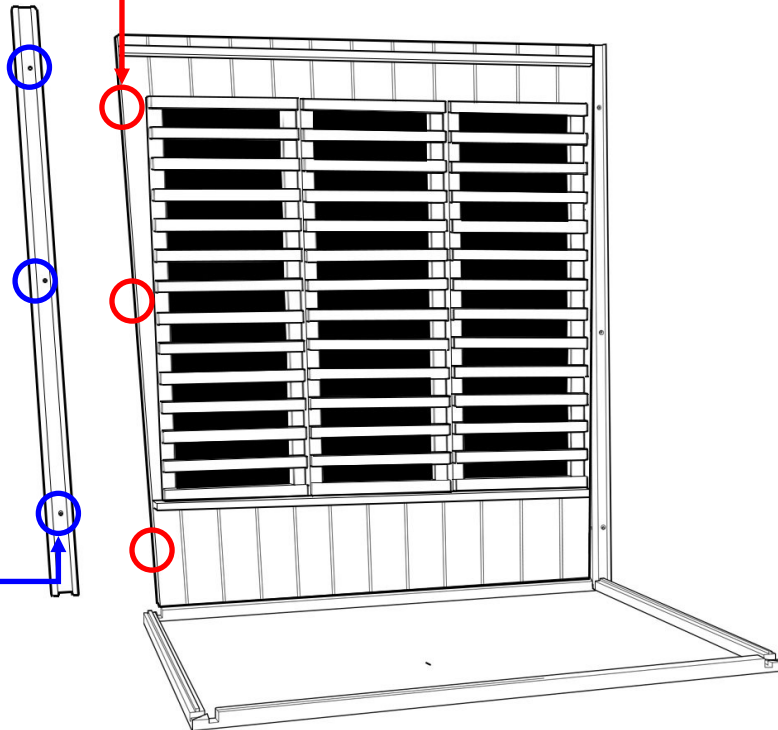
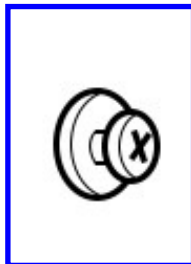

Step 5 — Installing the right side panel

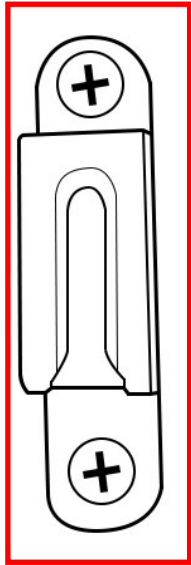

Lift the side panel and slide the brackets over the screw fixings and lock into position. Also ensure you push the panel down onto the right bottom strut and ensure they lock together.

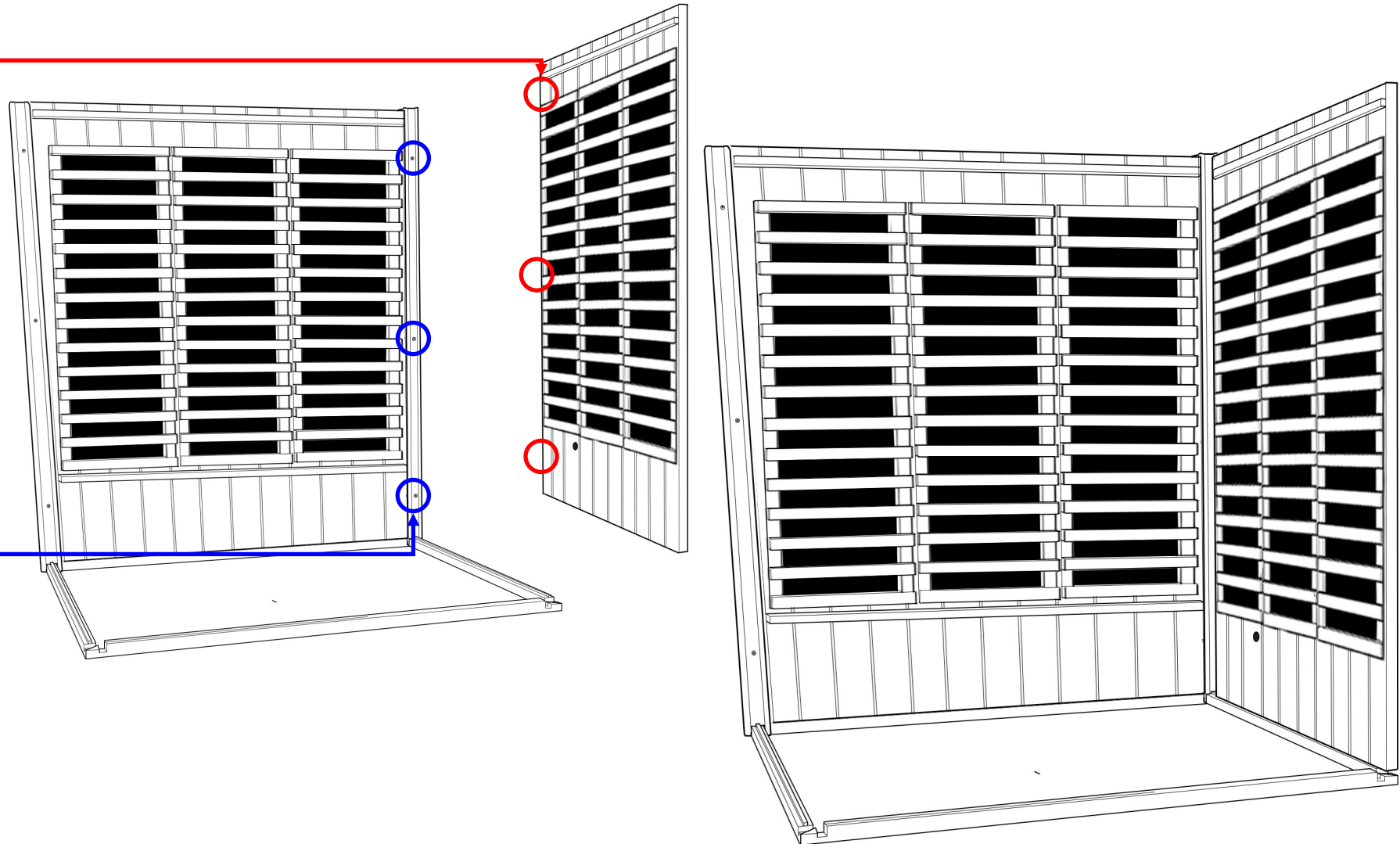

Step 6— Installing the right front upright

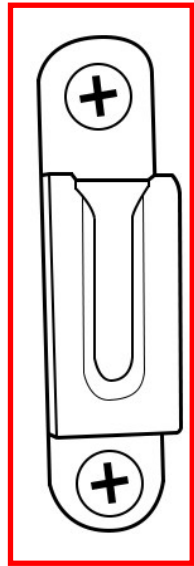

Slot the front right upright onto the side panel and push down to secure in position.

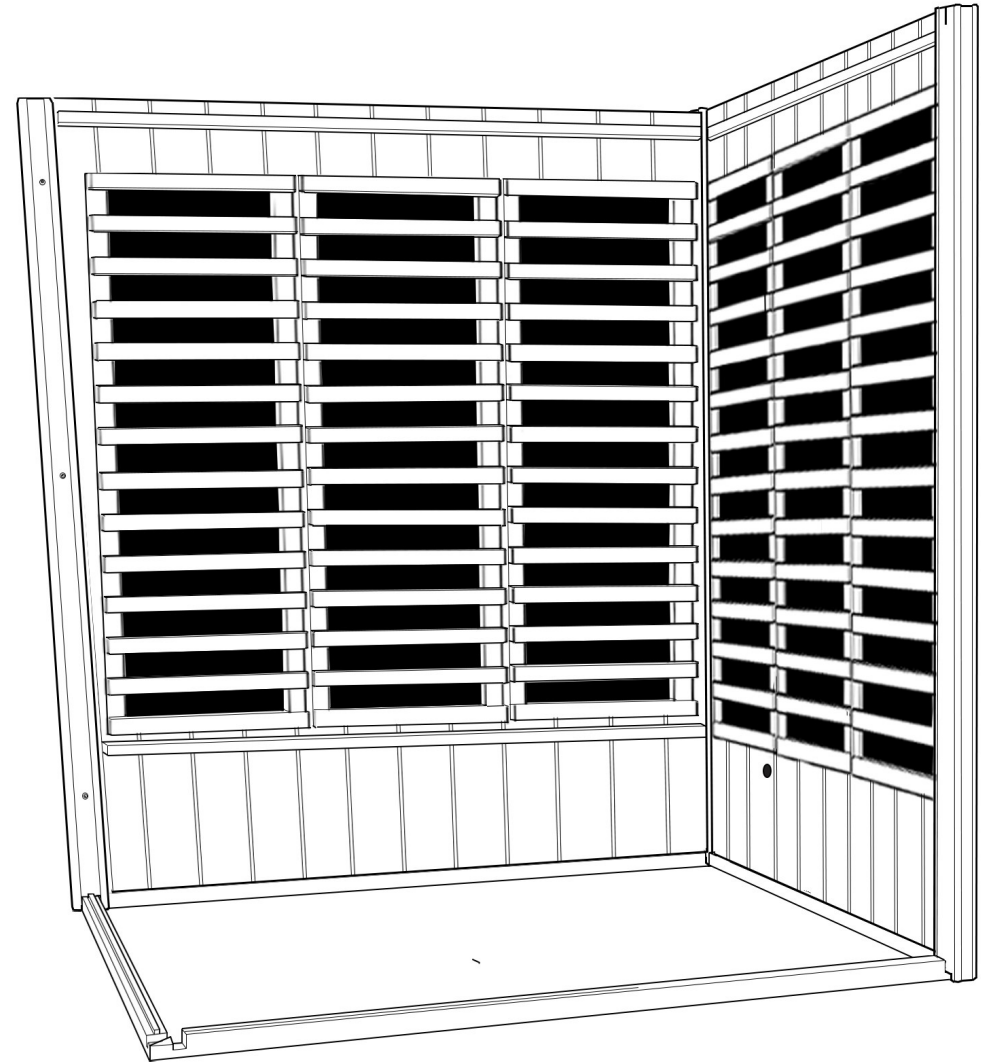
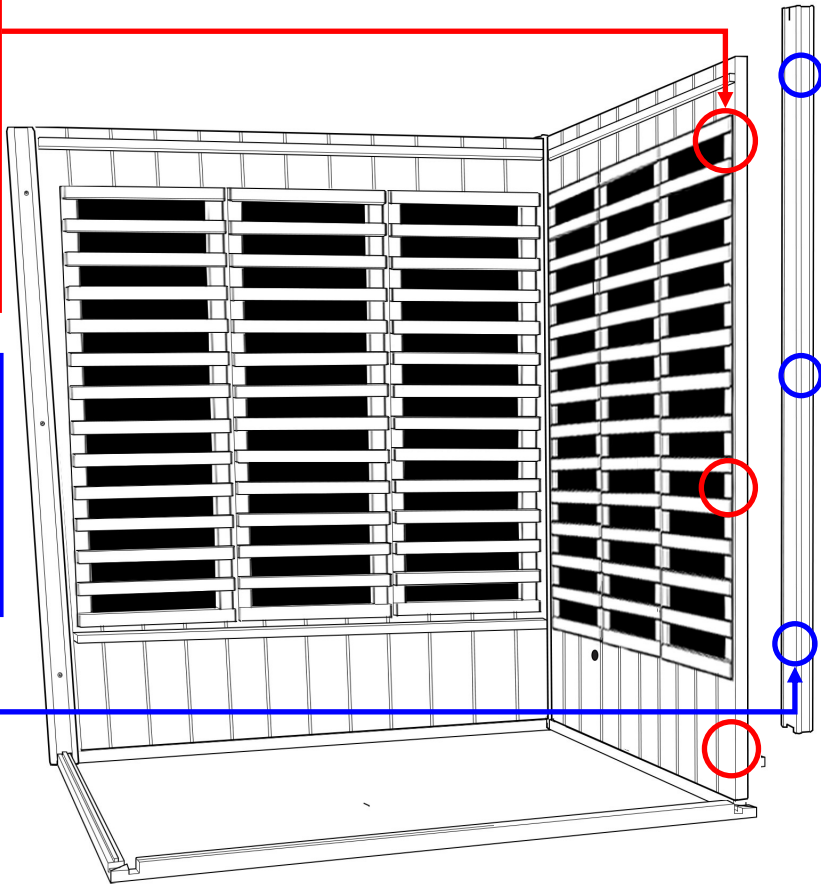
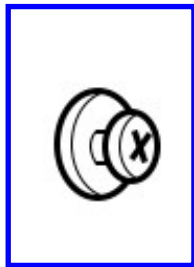

Step 7 — Installing the left side panel

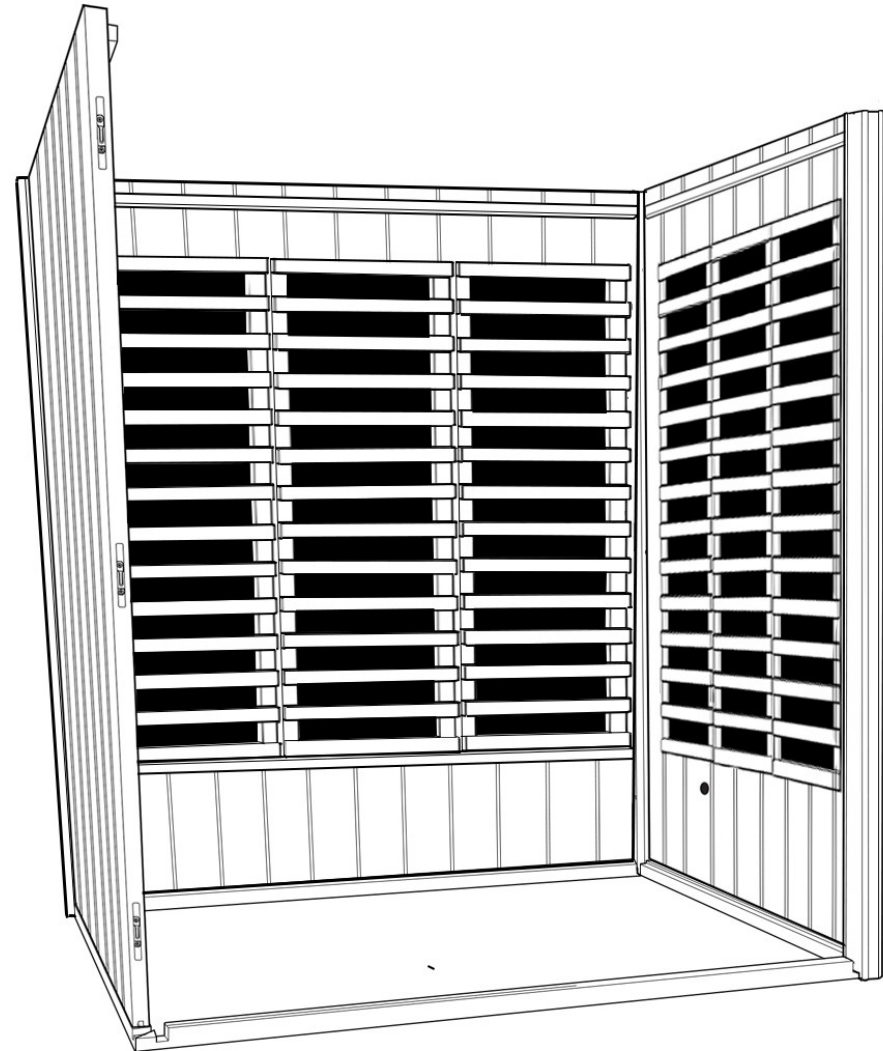
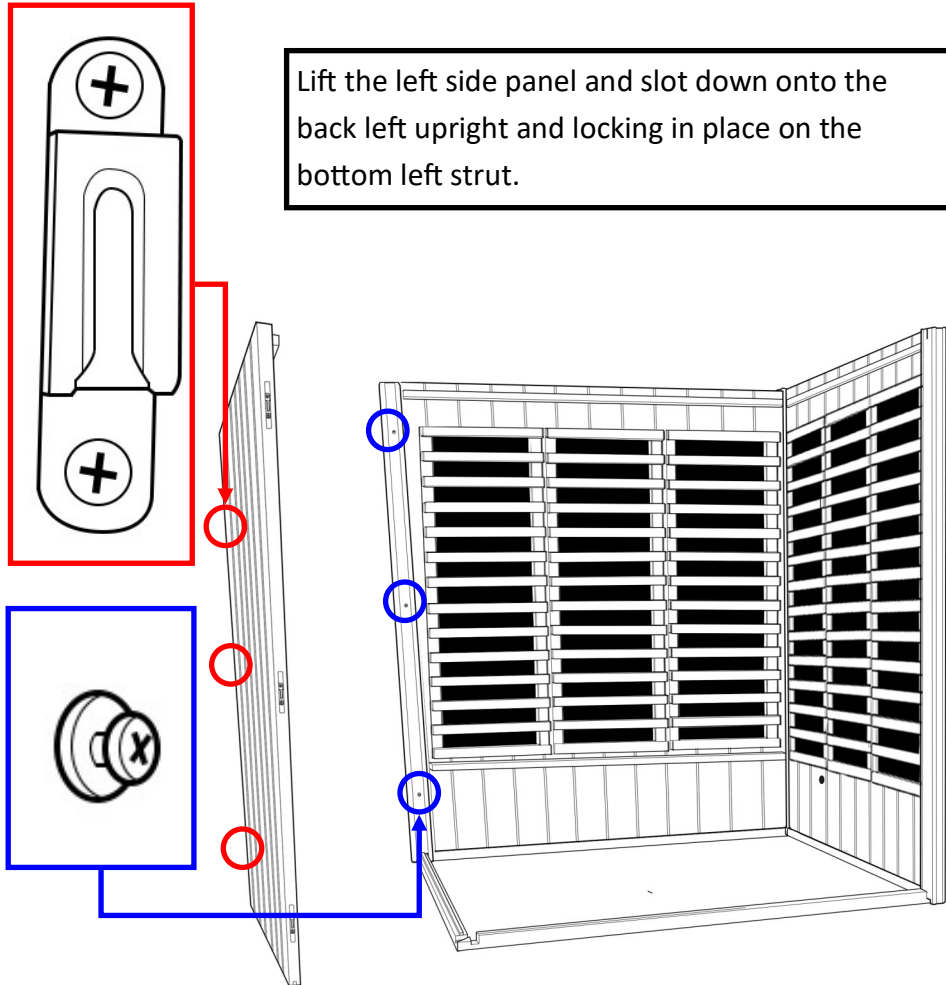

Step 8— Installing the front left upright

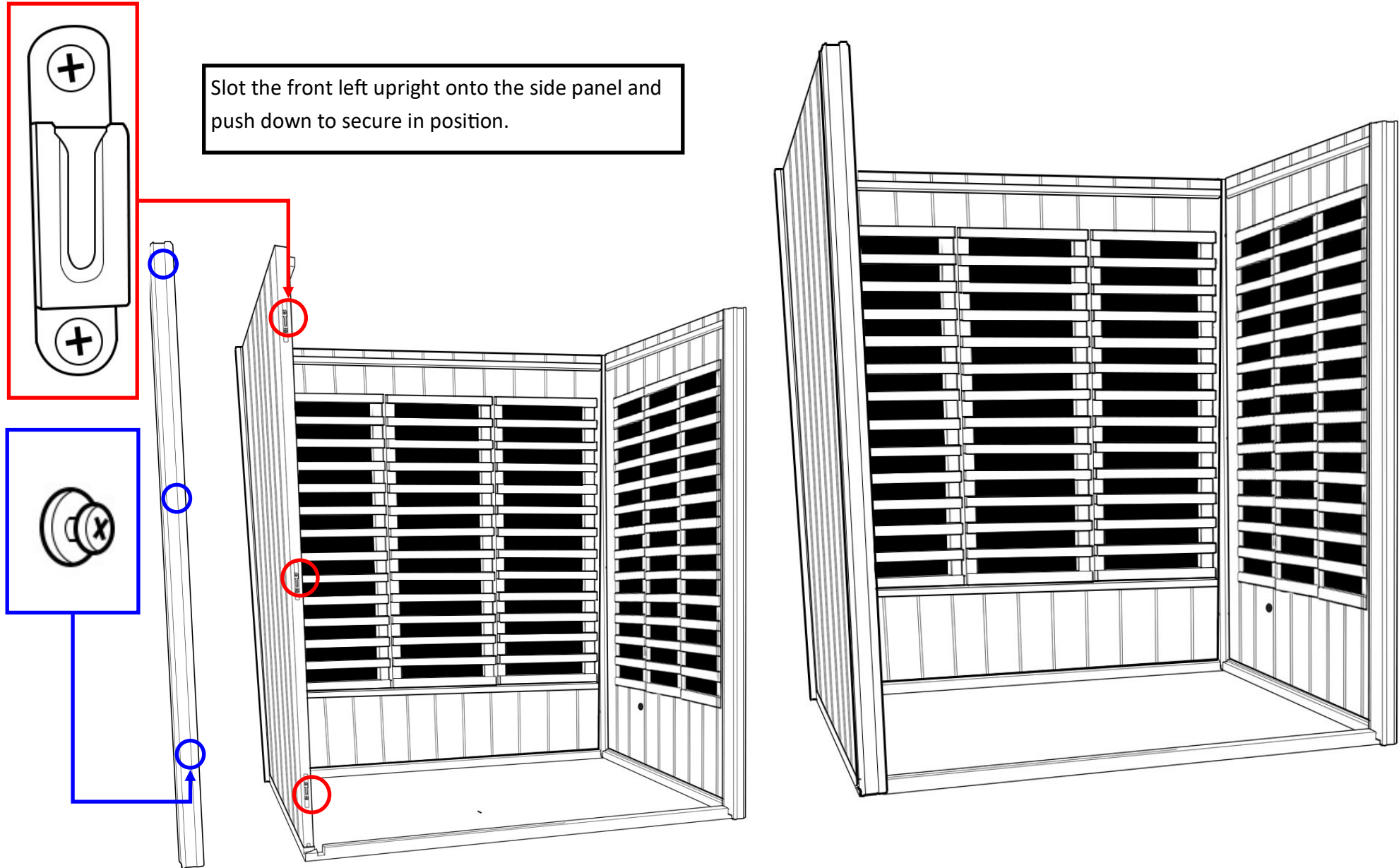

Step 9— Electric box

The electrical box (below) should be housed in the sauna, underneath the back bench on the floor. Install electrical connections. Partner up all corresponding wires which are denoted by matching stickers from the box to the back/right panels.

The electrical box should be placed with the items facing down and the lid facing up.

Note: It is recommended to make this connection now with full access.

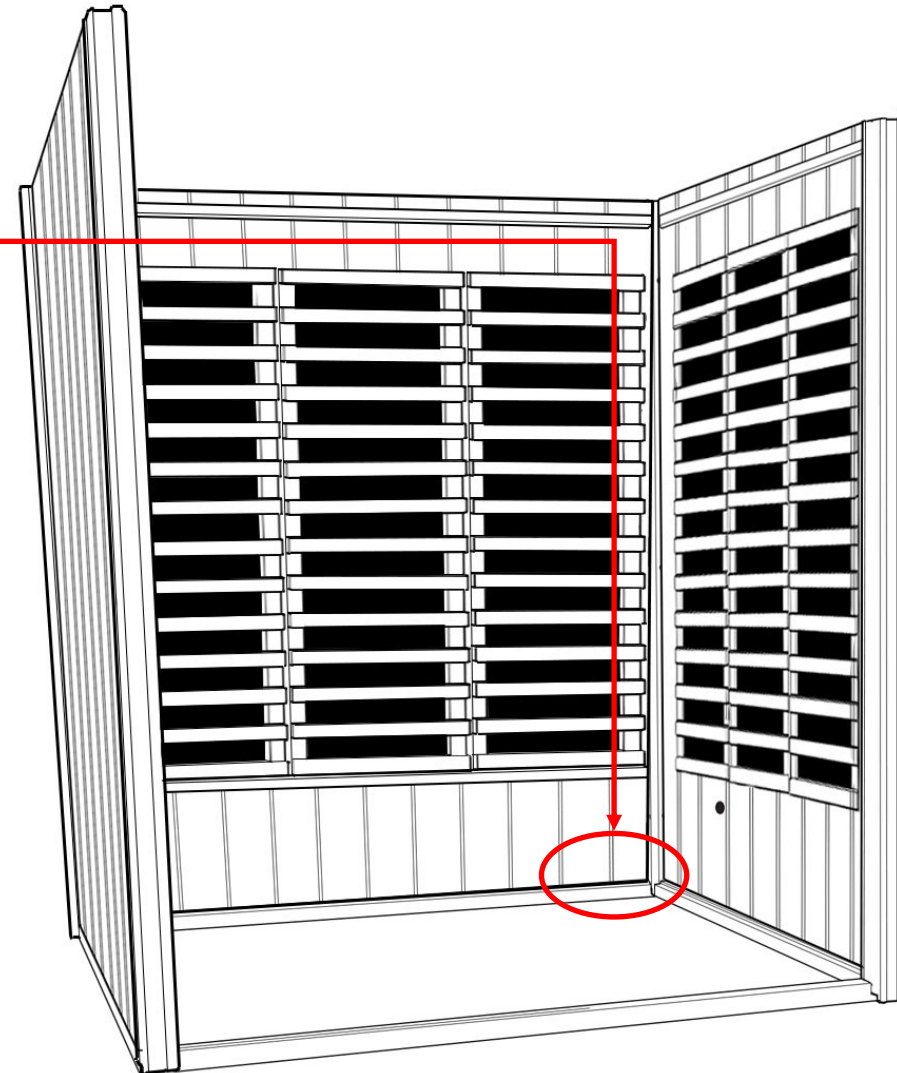
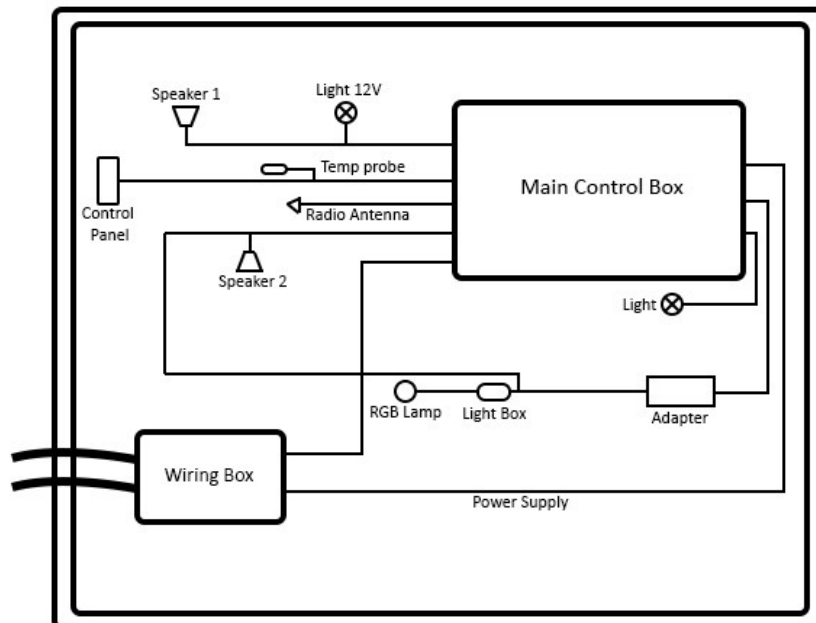

Step 10 — Installing the top frame

Locate the top framework into position. Secure loosely, as you need manoeuvrability of the framework to insert the fixed glass panel.

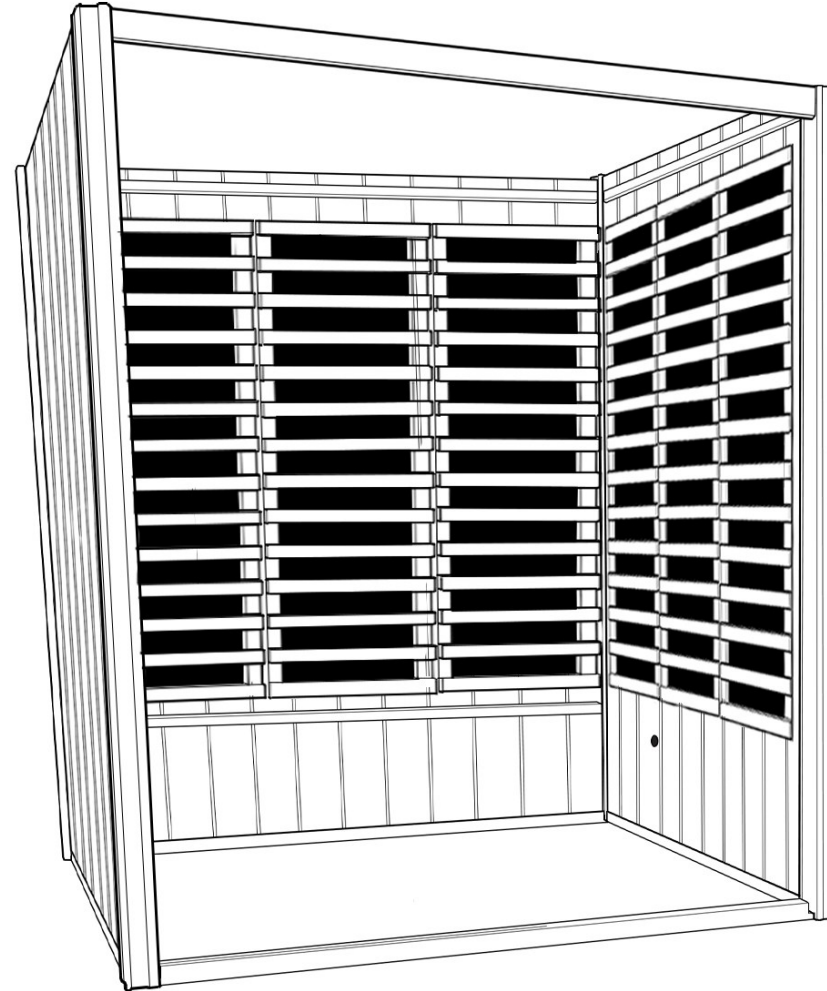
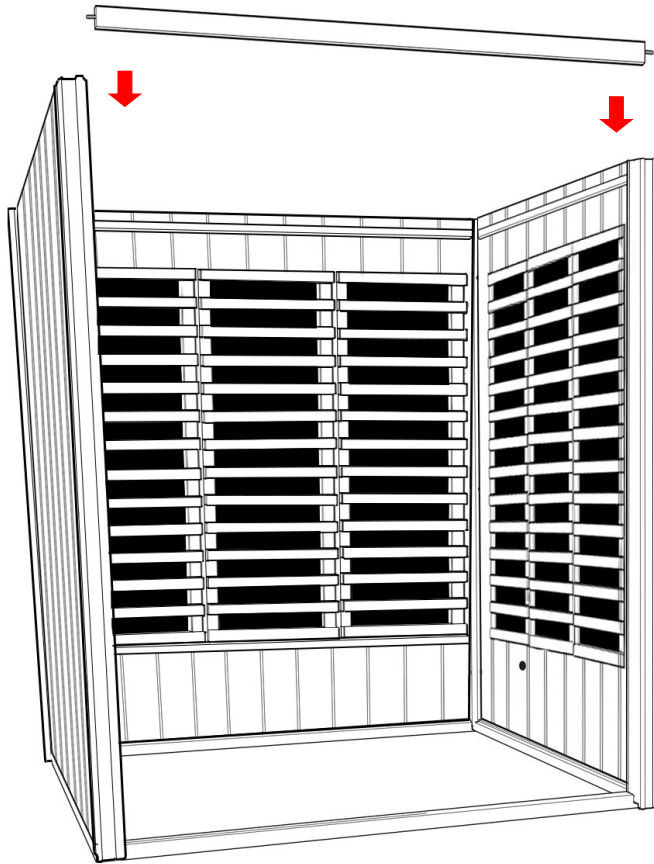

Step 11 — Placing the floor in position

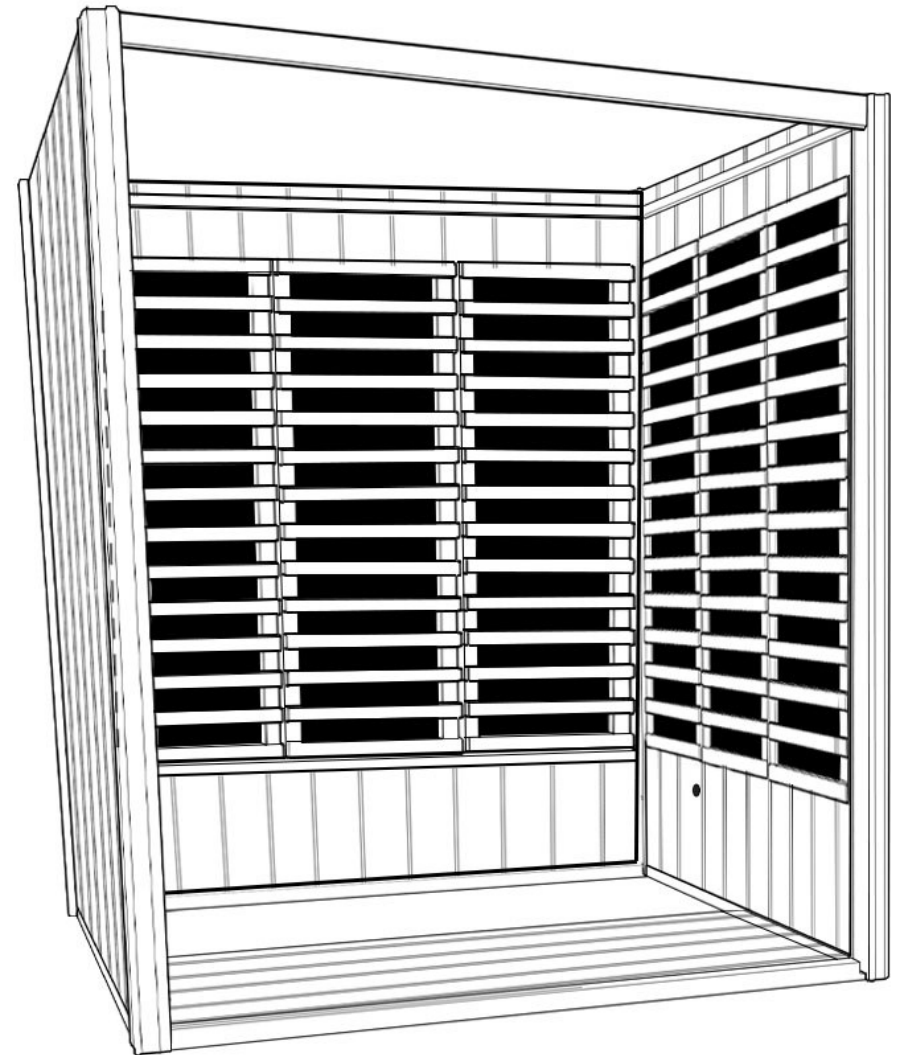
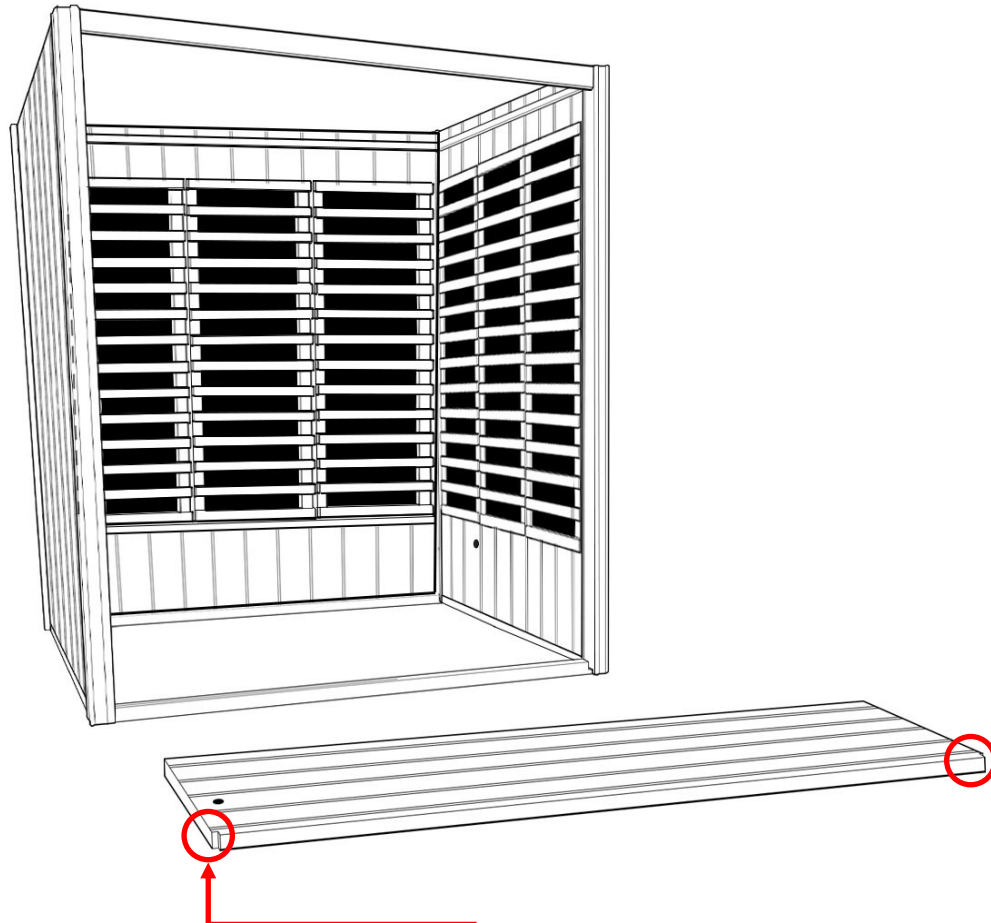

The cut-outs in each front corner go around the front uprights. Ensure you place the floor in it's correct orientation.

Step 12— Placing the front of the bench

Place the front of the bench tight up to the floor.

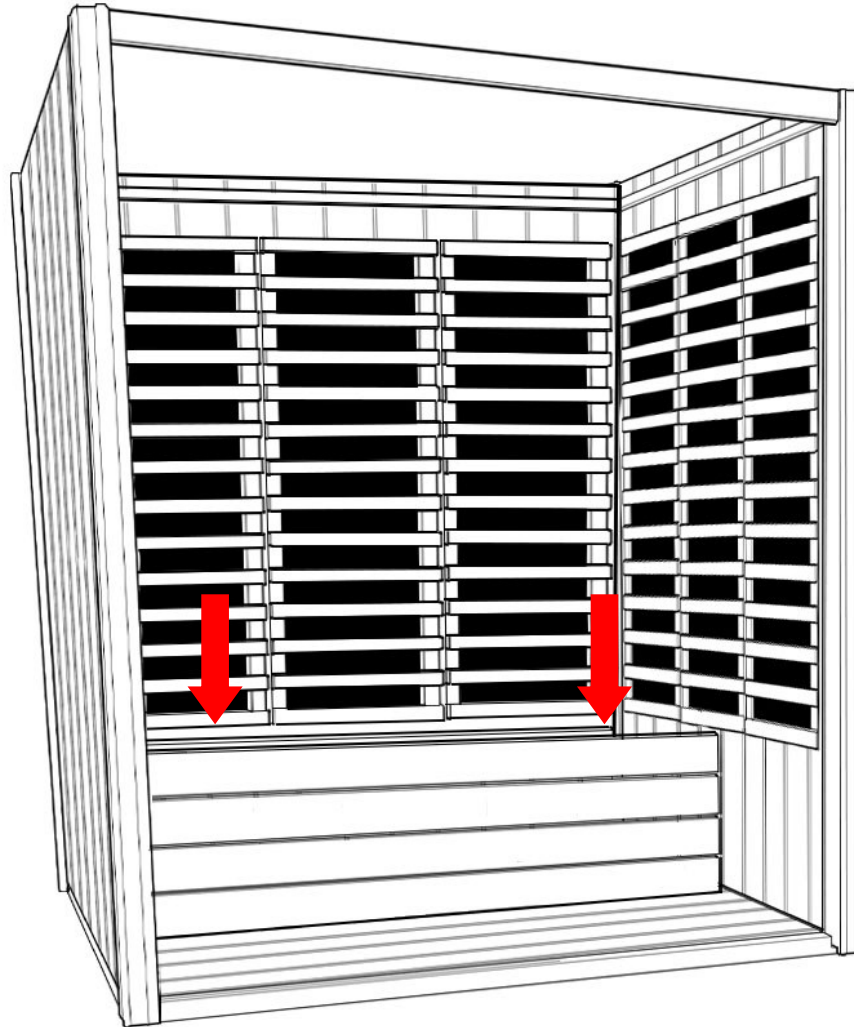
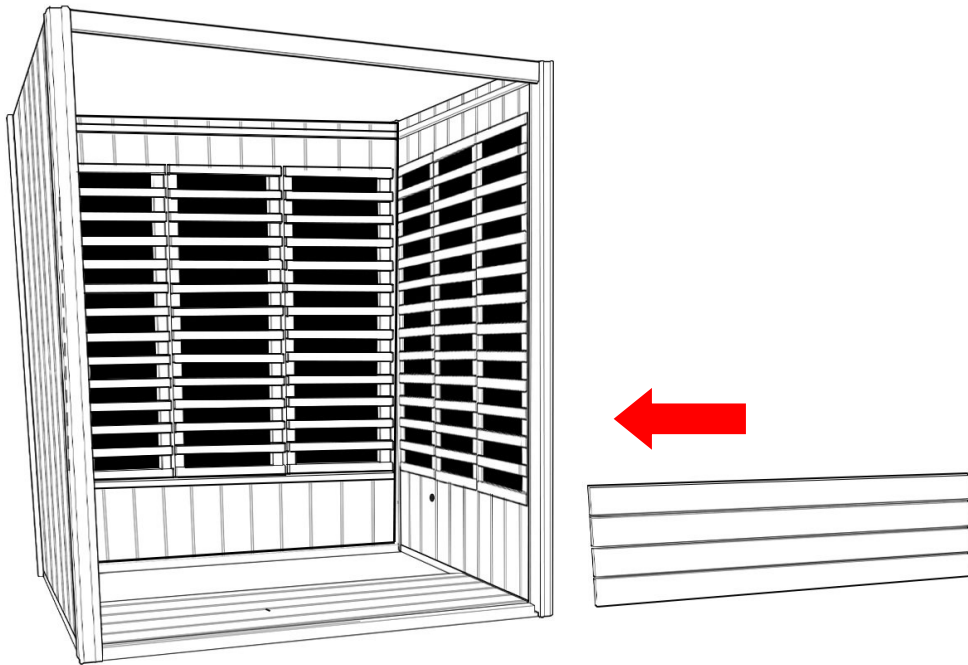

Step 13 — Placing under seat support frame

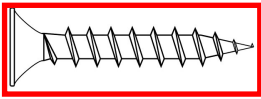

ST40 x 26

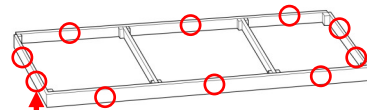
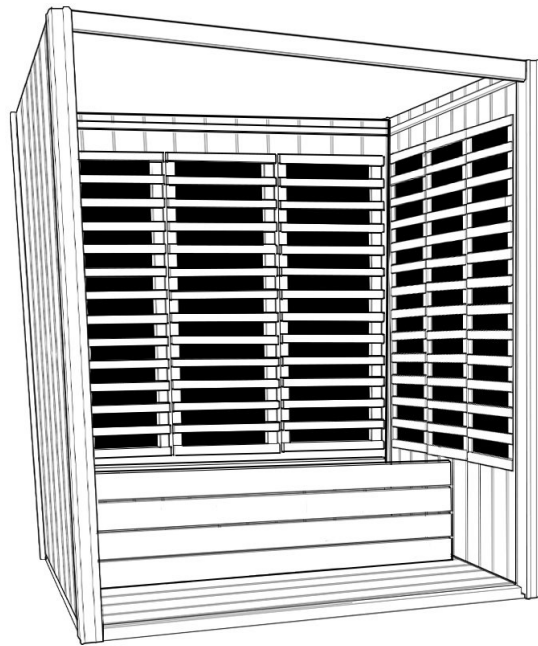

- Using ST40 Screws locate the large frame support to the back of the sauna.
- From the inside screw the base of all bench front to the adjoining panels.

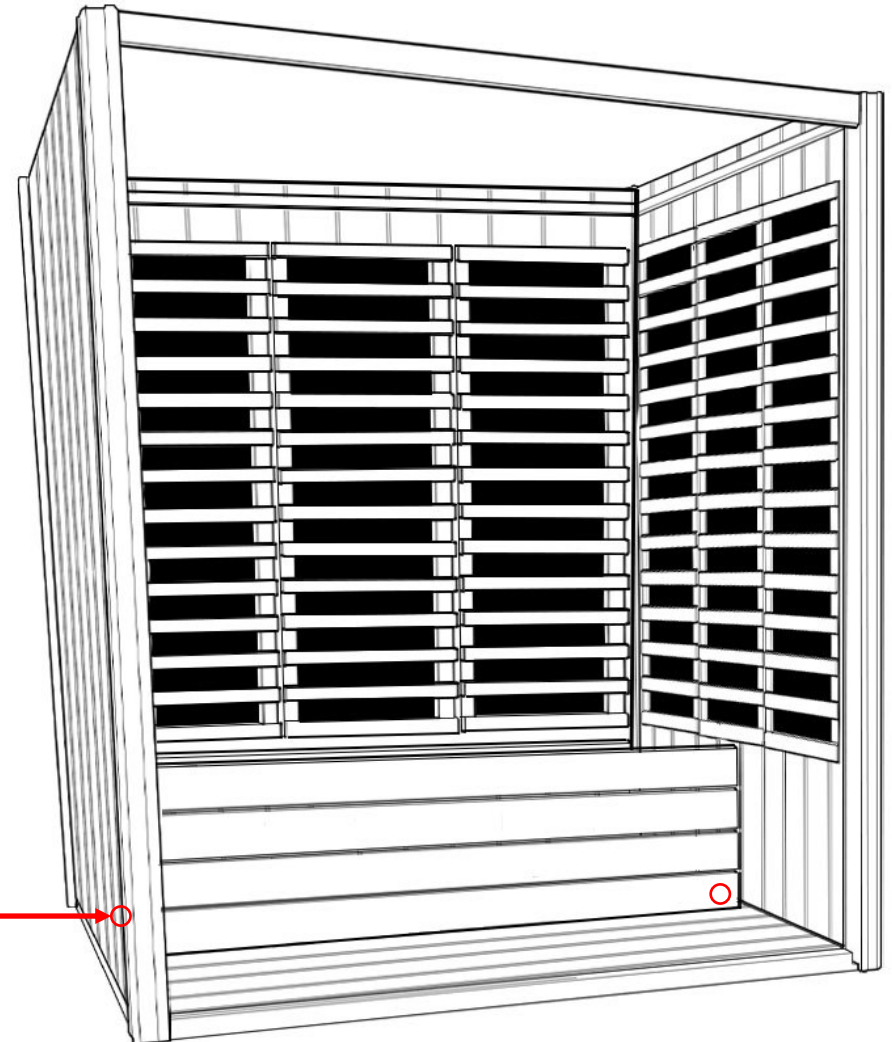

Step 14 — Placing the bench seat in position

Locate the bench seat into position by placing it onto the under support frame.

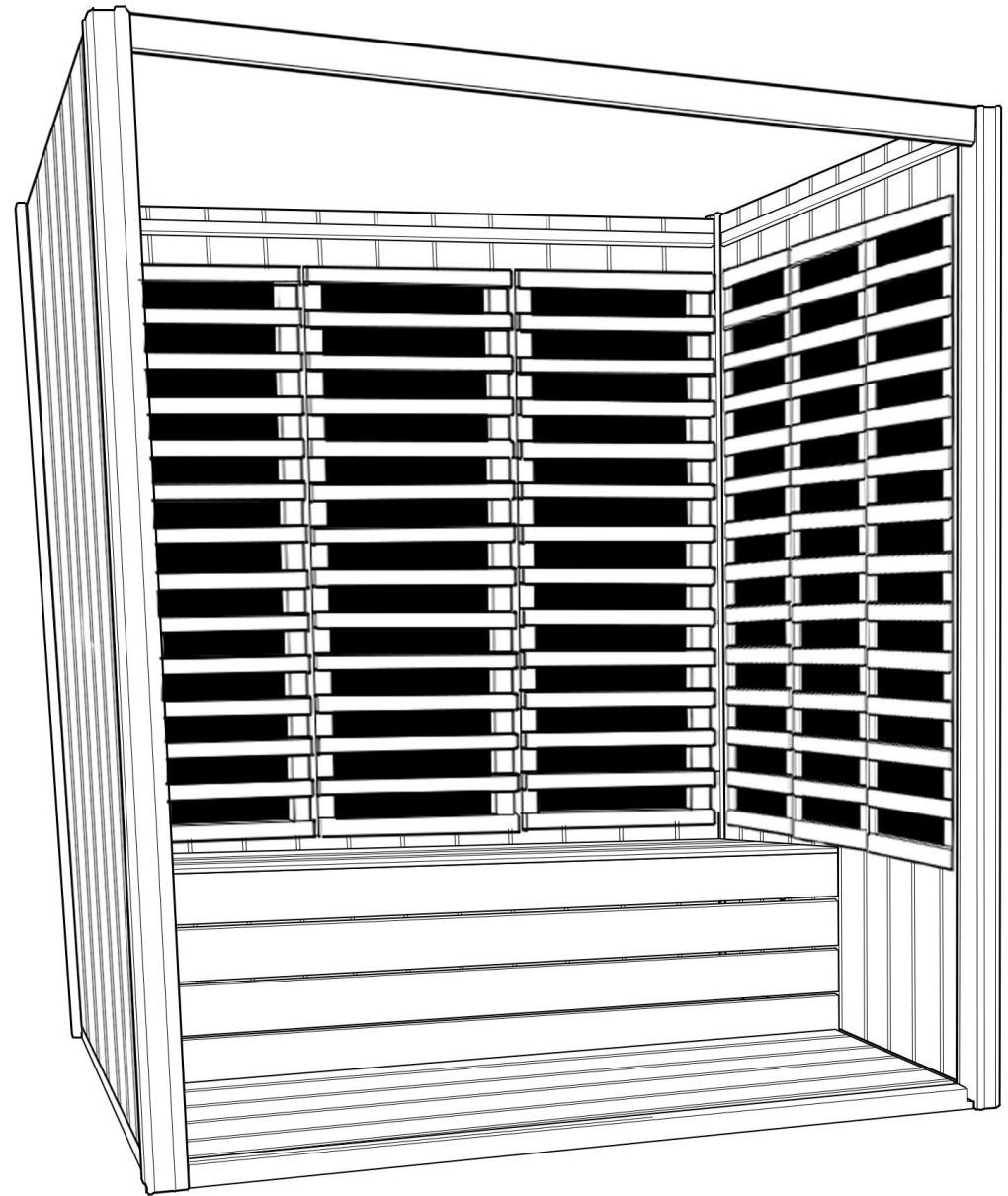
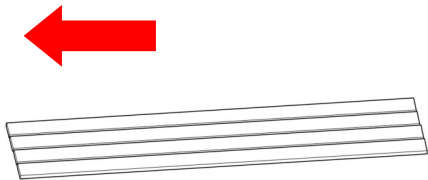
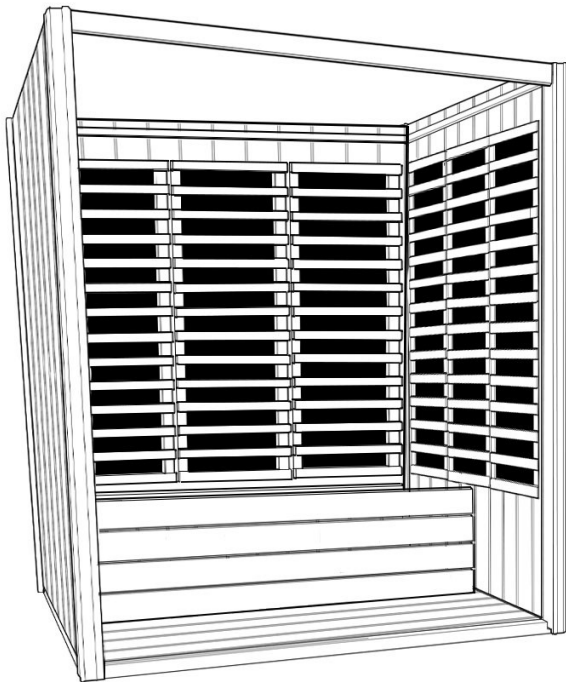

Step 15 — Installing the fixed glass panel

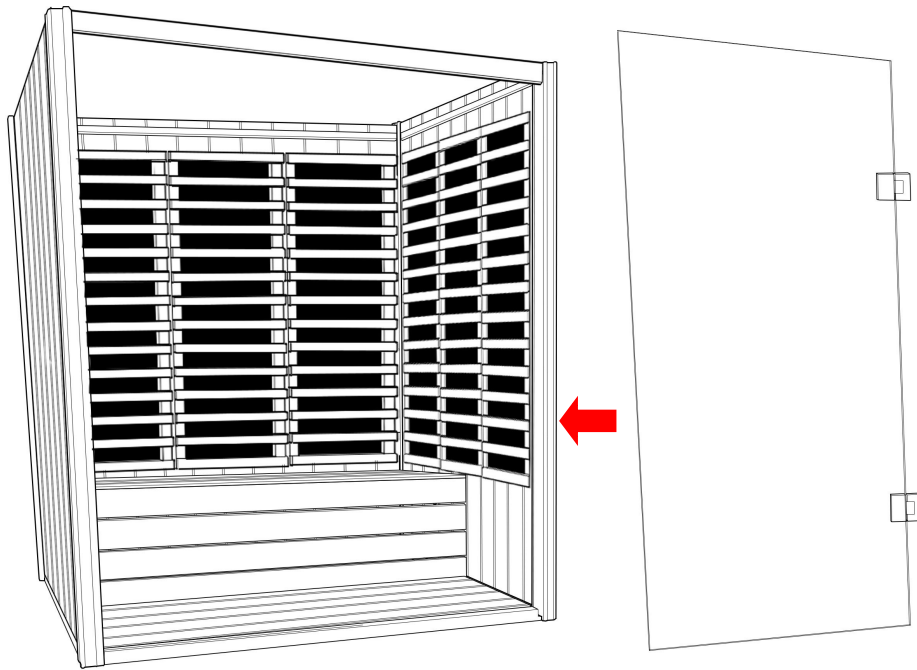

Insert the fixed glass into the groove cut-outs in the framework, lift the top framework up, then slot back down once it is in position.

Overhead view (right)

With the framework in position tighten the nut and washer from above.

Note: Be careful not to drop the hex nut and washer down the upright.

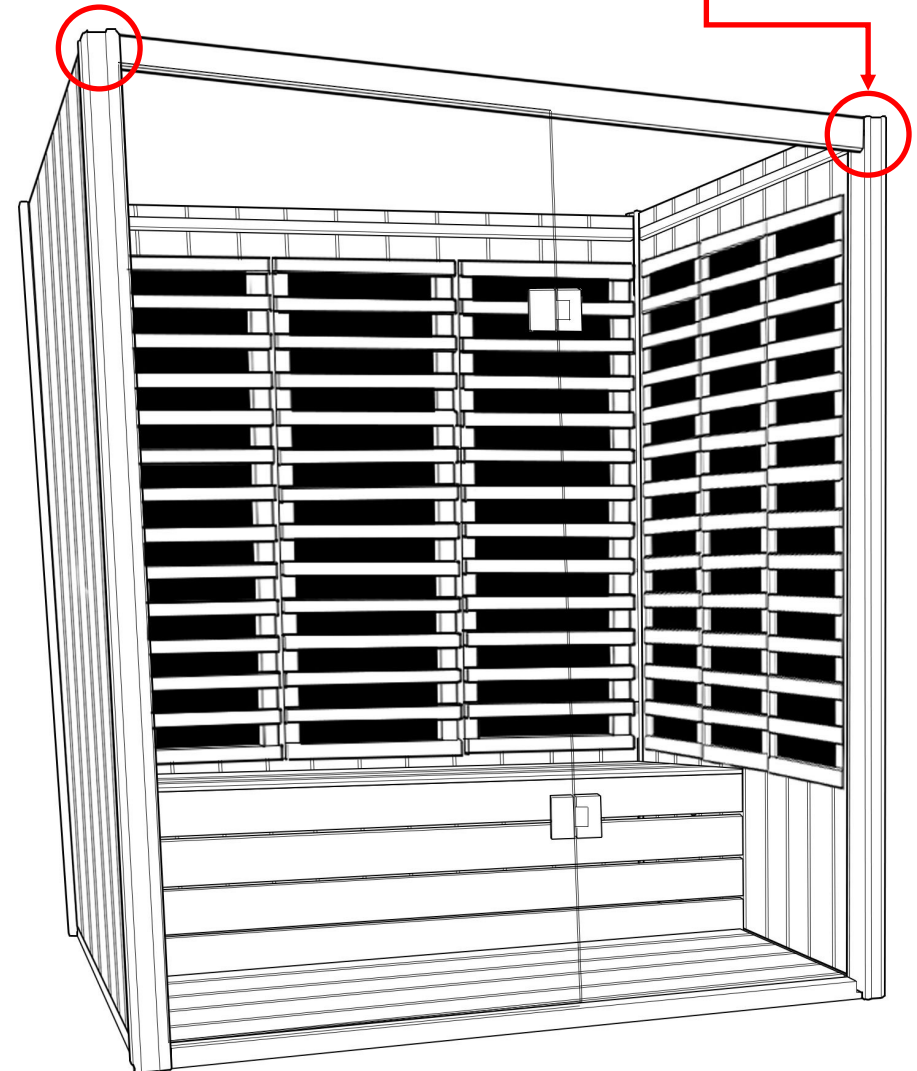
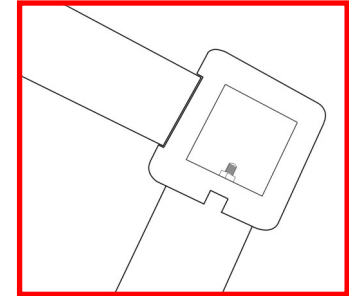

Step 16 — Installing the inner roof

Locate the inner roof and lift into position. Once in position, take all cabling from the back and side panel and connect on top of the inner roof.

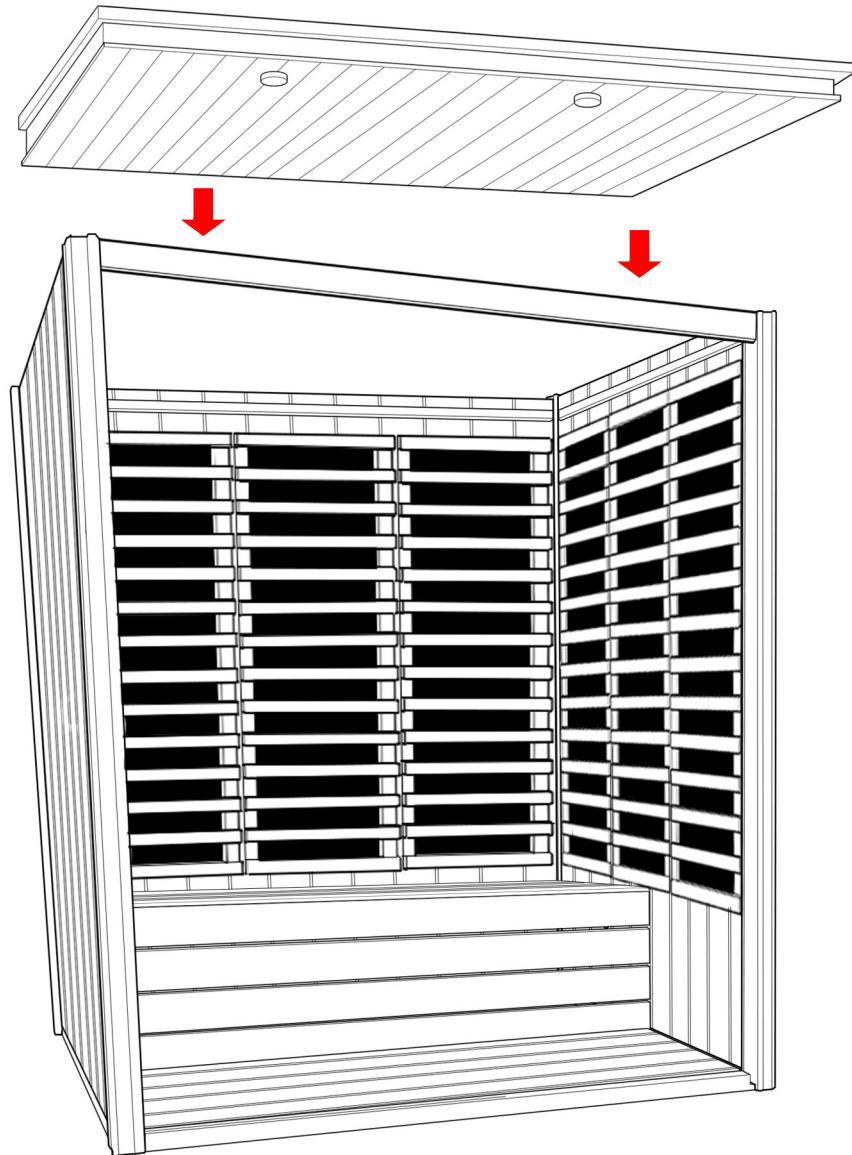

Locate the thermos probe and feed through the inner roof. Secure in position using silicone from above.

Ensure the probe extends approximately 75% out.

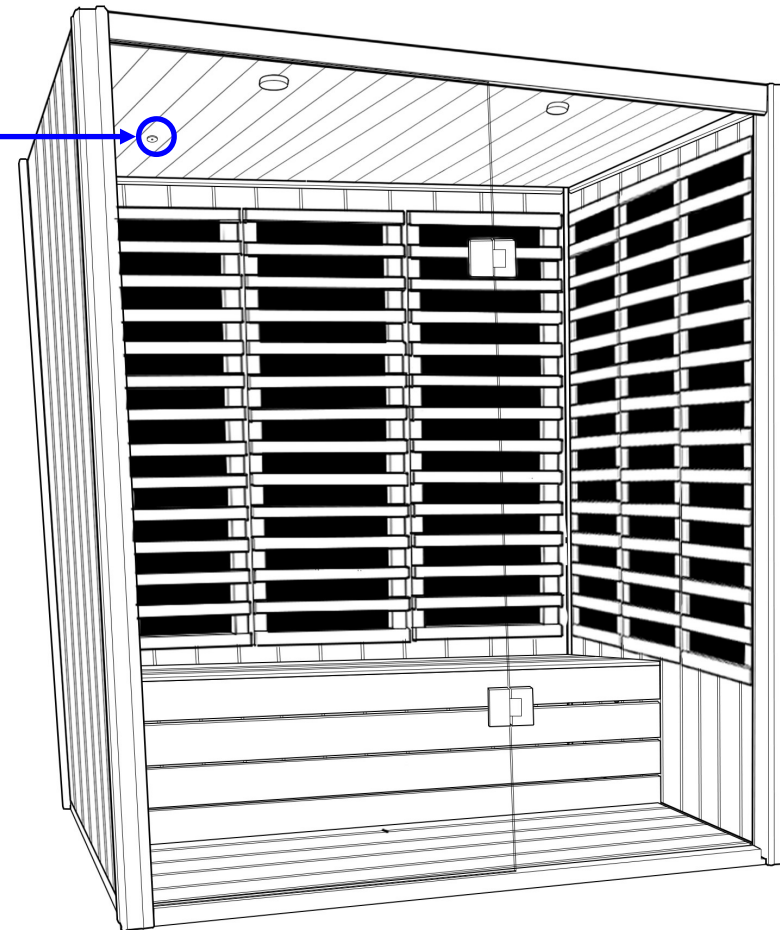
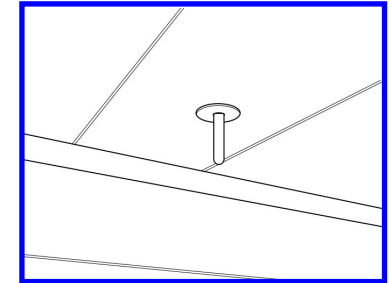

Step 17 — Installing the big roof

Lift the roof into position and position the square locaters into the top of all uprights.

Caution: Roof is heavy, Minimum 2 person lift advised.

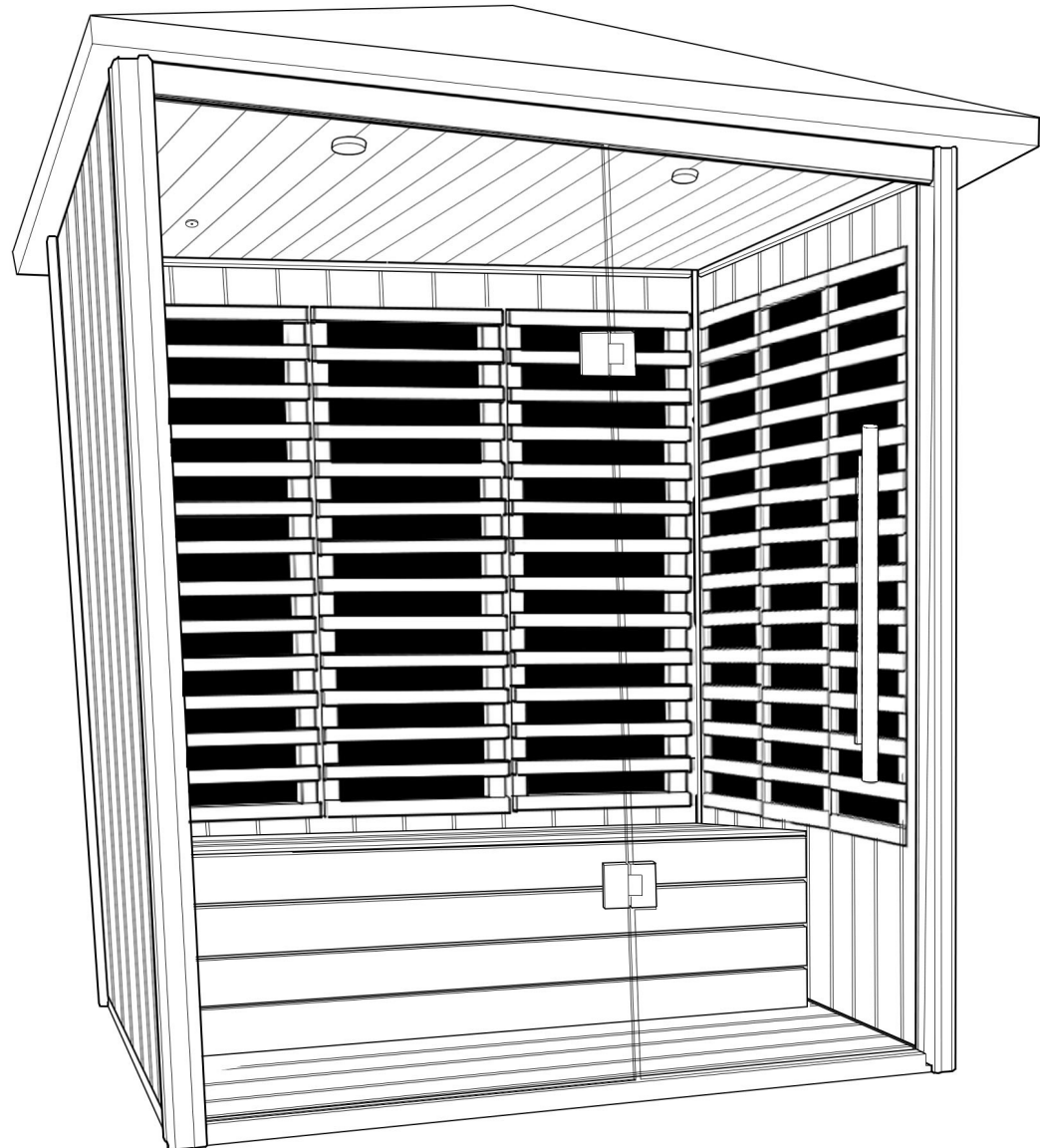
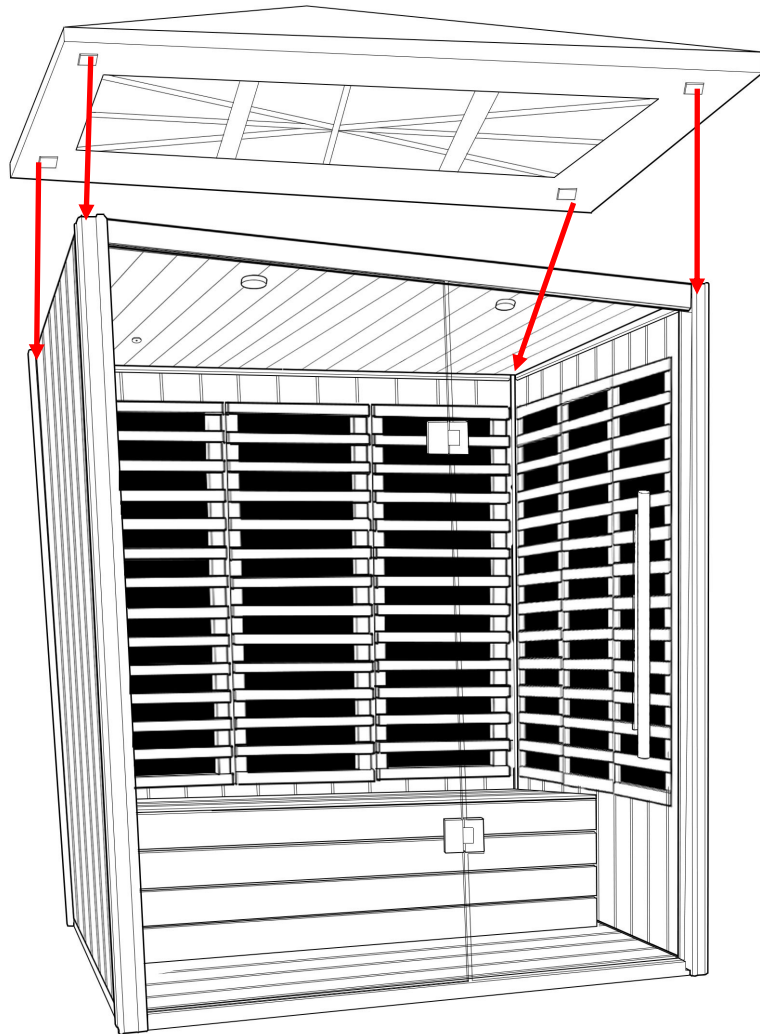

Step 18 — Installing the door handle

Locate the door handle and separate before attaching it to the door. The metal handle is designed to be on the outside of the sauna.

The door will be positioned here.

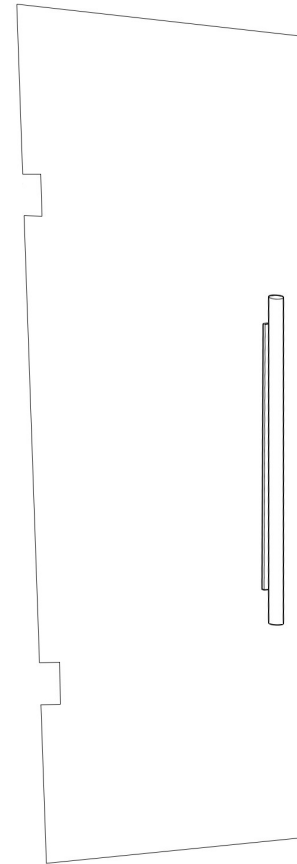
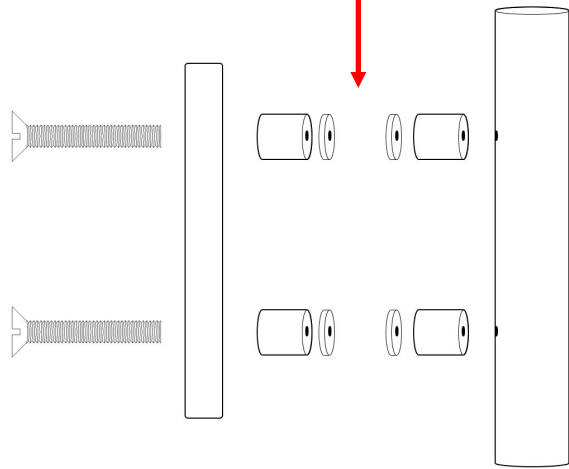

Step 19 — Installing the door

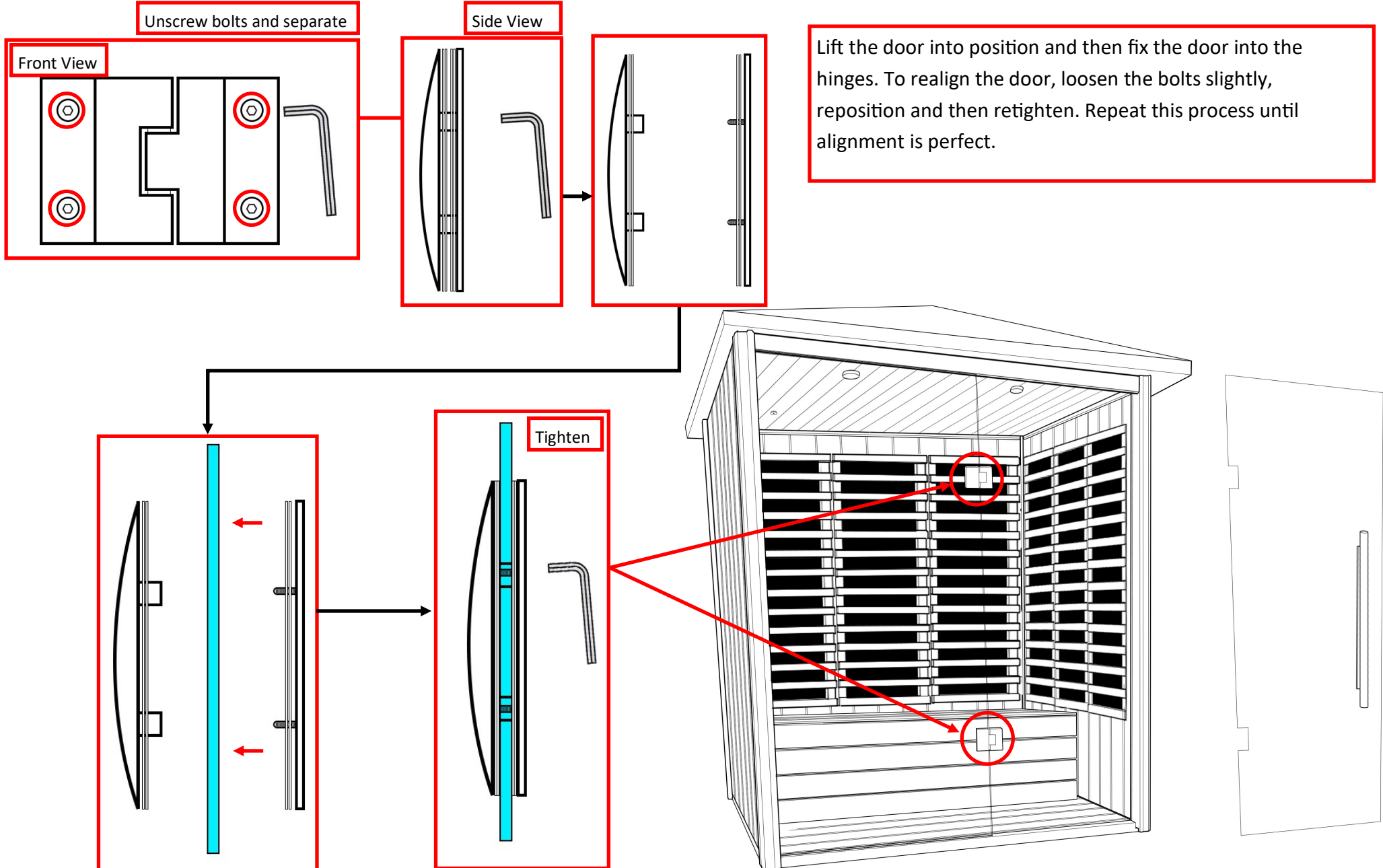

Step 20 — Accessories Installation

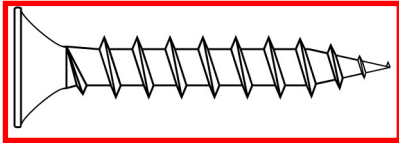

40mm Screws

Connect the light from the wire fed through the pre drilled hole in the back panel. Screw into position.

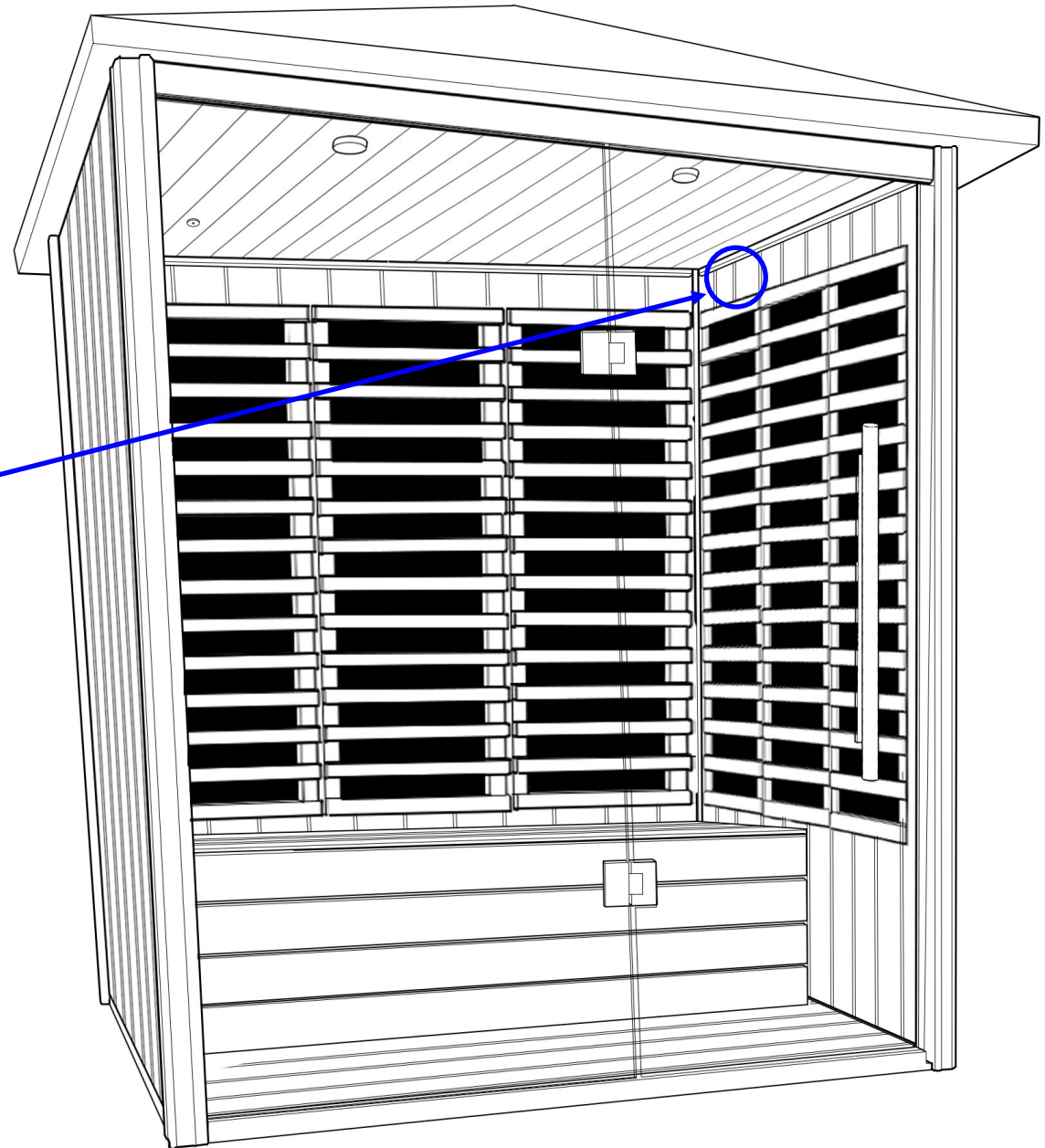
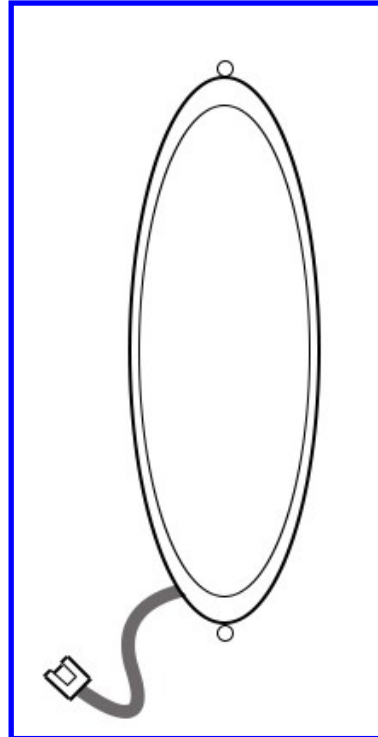

Control Panel Instructions

Button 1 (Lights)

Turn the 12V light on or off.

Button 2 (Return)





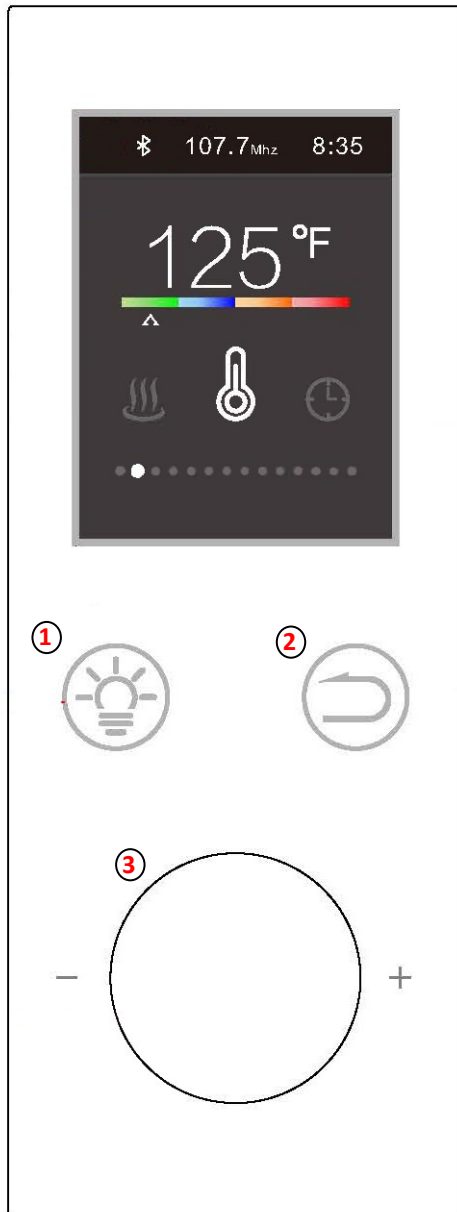

Press to return to the menu after a change is made.

Button 3 (Mode button/Scroll)

Press and hold for 3 seconds to power the panel on or off.

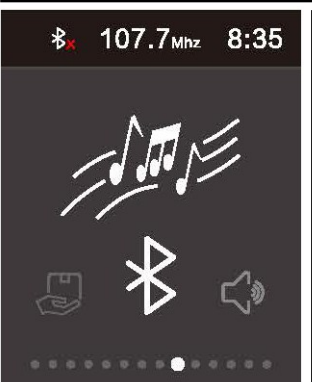
Press to change the control panel function, then scroll left or right to change settings. The panel automatically locks after 1 minute of inactivity. Press this button to unlock the panel.

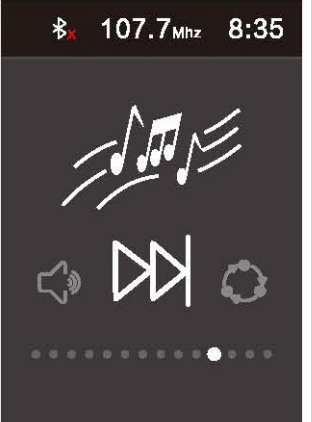

<p style="text-align: center;">Coloured Lights</p>	<p style="text-align: center;">FM Radio</p>	<p style="text-align: center;">Volume</p>			
	<p>To operate the lights, press (Button 3) until you see the interface (left). Once here press (Button 3) and scroll through the light options.</p>		<p>To operate the FM Radio, Scroll (Button 3) until you see the interface (left). Once here, press (Button 3) to begin playing.</p>		<p>Scroll (Button 3) until you see the interface (left). Once here, press (Button 3) to enter the volume mode. Scroll up or down to change the volume.</p>
<p style="text-align: center;">Bluetooth Connectivity</p>	<p style="text-align: center;">FM Radio Station Search</p>	<p style="text-align: center;">Sauna Setting</p>			
	<p>To operate the Bluetooth, scroll with (Button 3) until you see the interface (left). Scan for the control panel on your device and pair. Once paired you should hear a connection tone. Press play on your device to begin listening.</p>		<p>Scroll (Button 3) until you see the interface (left). Once here, press (Button 3) and scroll to search through until it finds a station. Press again to continue searching.</p>		<p>Scroll (Button 3) until you see the interface (left). Once here, press (Button 3) to enter the sauna mode. This will toggle the Sauna heater on/off as desired. Use the Time/Temp settings to make the most out of your session.</p>
<p style="text-align: center;">Bluetooth Track Change</p>	<p style="text-align: center;">FM Radio Station Save</p>	<p style="text-align: center;">12V Light Interface</p>			
	<p>To change track whilst in the sauna form the panel, scroll to the audio interface (left). Then press the scroll (Button 3) and it will change to the next track. This will also change through the saved radio station list you have made. You can only skip forwards, not backwards.</p>		<p>Scroll (Button 3) until you see the interface (left). Once here, press (Button 3) and it will save the current radio station you are listening to. You can save up to 10 stations on this device.</p>		<p>Scroll (Button 3) until you see the interface (left). Once here, press (Button 3) to turn off the 12V light. Press again to turn it on. The light will turn on automatically when the panel is turned on.</p>

Settings



Scroll (Button 3) until you see the interface (left). Once here, press (Button 3) to enter the settings mode. Here you can set the clock which operates on a 24 hour system. You can also change the temperature display to Celsius or Fahrenheit. Change either by entering the setting using (Button 3) and then scroll to change. Press (Button 3) again to confirm selection.

Time/Temp Setting



For temperature: Scroll (Button 3) until you see the interface (left). Once here, press (Button 3) to enter the temp mode. Scroll until desired temperature and simply press (Button 3) to confirm.



For time: Scroll (Button 3) until you see the interface (left). Once here, press (Button 3) to enter the time mode. Scroll until desired duration is set and simply press (Button 3) to confirm.

Sauna Usage & Safety Guide

1. Never leave children unattended in the Sauna.
2. Regulate (if preferred) the temperature of sauna before session - Pre-heat time 15-30 minutes (from room temperature 20c)
3. Never touch the heater panels whilst in operation, possible burning may occur.
4. Recommended time of use is a maximum of 15 mins initially. We highly recommend working up in time to this, beginning with 5 minute sessions to get your body used to using a sauna.
5. Suggested operational heat range: Infrared—38o C-65o C. Infrared optimum use range 35 C to 45 C
6. Stay hydrated during each Sauna session.
7. Exit the sauna immediately if feeling dizzy, faint or short of breath.
8. Do NOT use the sauna if you're pregnant, have a heart condition, have low or high blood pressure. If you're unsure consult your GP before use.
9. If you have any underlying health conditions which you feel could be aggravated by an increase in temperature, consult your GP before use.
10. If you begin to have any issues with your health after using a sauna, stop immediately and consult your GP regarding your symptoms before continuing to use.
11. Consult your GP before using the sauna room if you're on medication at all, especially with drowsy side effects.
12. Never use this sauna if you have been drinking alcohol or under the influence of other substances.
13. Do not put combustible material on the heaters at any time.
14. Always turn power supply off after use.

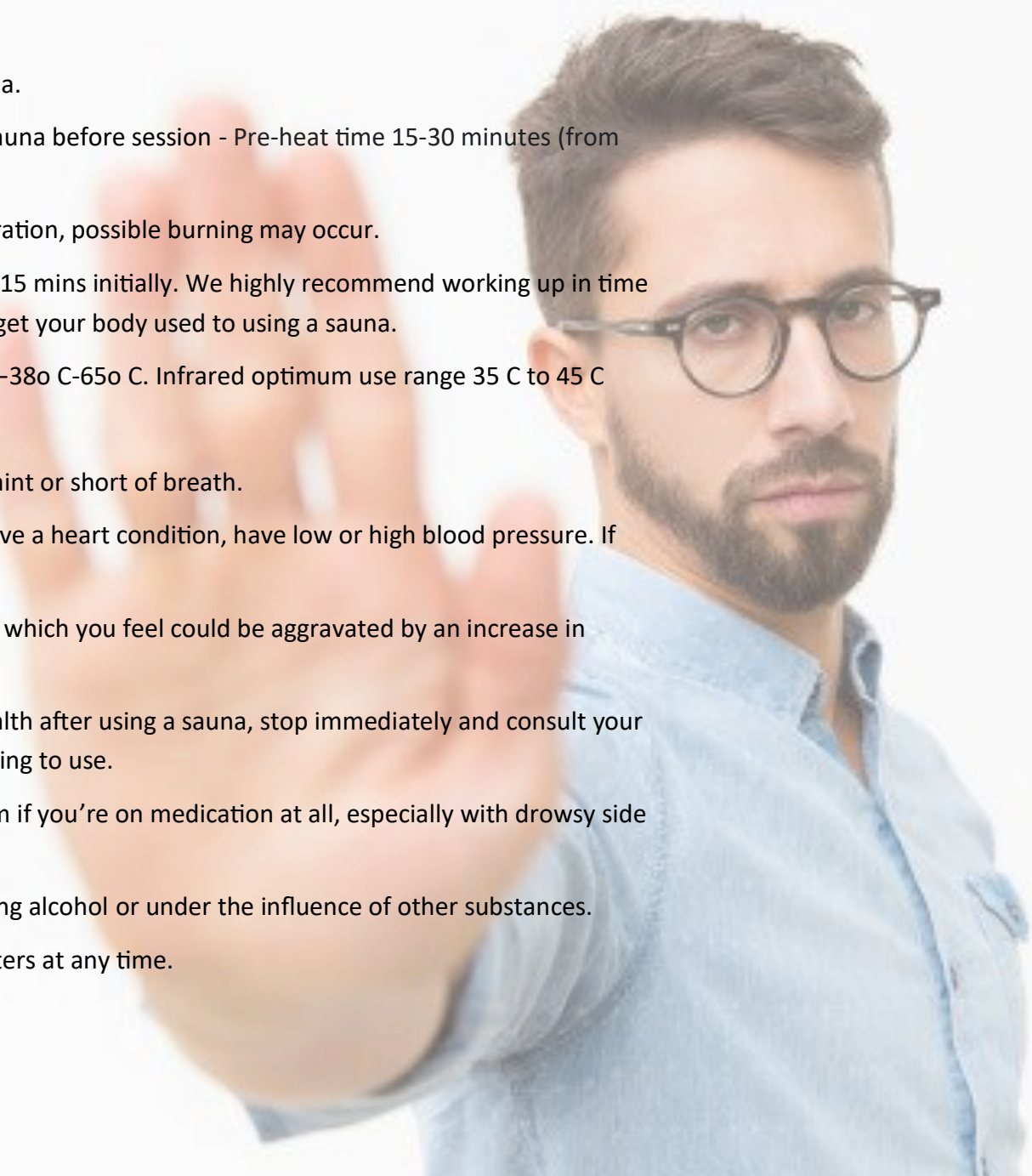

WEEE Compliance Statement

The UK Waste Electrical and Electronic Equipment (WEEE) regulations came into force on 2 January 2007. Under this new legislation, producers of electrical and electronic equipment (EEE) have to fulfil certain obligations.

Under the WEEE directive Insignia is considered the producer of certain products we supply and in line with the demands of the legislation we are pleased to offer the opportunity to return these products to us for treatment and recycling.

Insignia products will generally have an identifying mark and the common crossed out wheelie bin label. We accept returns of all products carrying the Insignia brand. All other products are either considered outside the scope of WEEE or Insignia is not technically the producer of these products. Insignia also accepts historic like-for-like WEEE returns. All WEEE returned to Insignia will be recycled in appropriate treatment and recycling centres in accordance with the legislation. If you wish to return any products to us, please send your item(s) to our head office.

Company Contract No. 326457

WEEE Producer No. CBDU64227

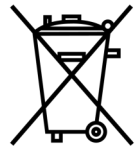

LABELLING

Products labelled with the WEEE symbol (a crossed out “waste bin”) indicate that the final user should not discard this product along with other household waste, but that it must be collected and treated separately.



Returns Address for WEEE

Insignia

9a Deans Road, Old Wolverton, Canon Industrial Park, Milton Keynes, Buckinghamshire, MK12 5NA, UK



EU – Declaration of Performance

Insignia declares that all its products complies with the essential requirements and other relevant provisions of Directive 305/2011/EC. A copy of the Declaration of performance is available from www.insigniashowers.com/ce-certification

Insignia™ is a registered trademark of Maclean International Ltd, 9a Deans Road, Old Wolverton, Canon Industrial Park, Milton Keynes, Buckinghamshire, MK12 5NA, UK

All images are subject to copyright. Images may not be used in any way shape or form with out written permission from Maclean International Ltd. Images are NOT permitted to be saved, printed or uploaded. Violation of copyright laws are punishable by law.

All images are registered with
ImageTraker

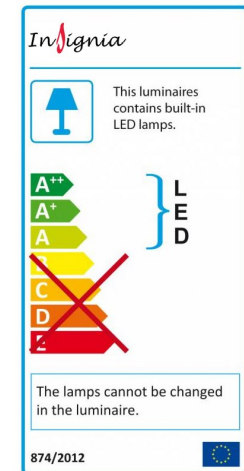

Insignia™ is a registered trademark of Maclean International Ltd

All images are subject to copyright. Images may not be used in any way shape or form with out written permission from Maclean International Ltd. Images are NOT permitted to be saved, printed or uploaded. Violation of copyright laws are punishable by law.