

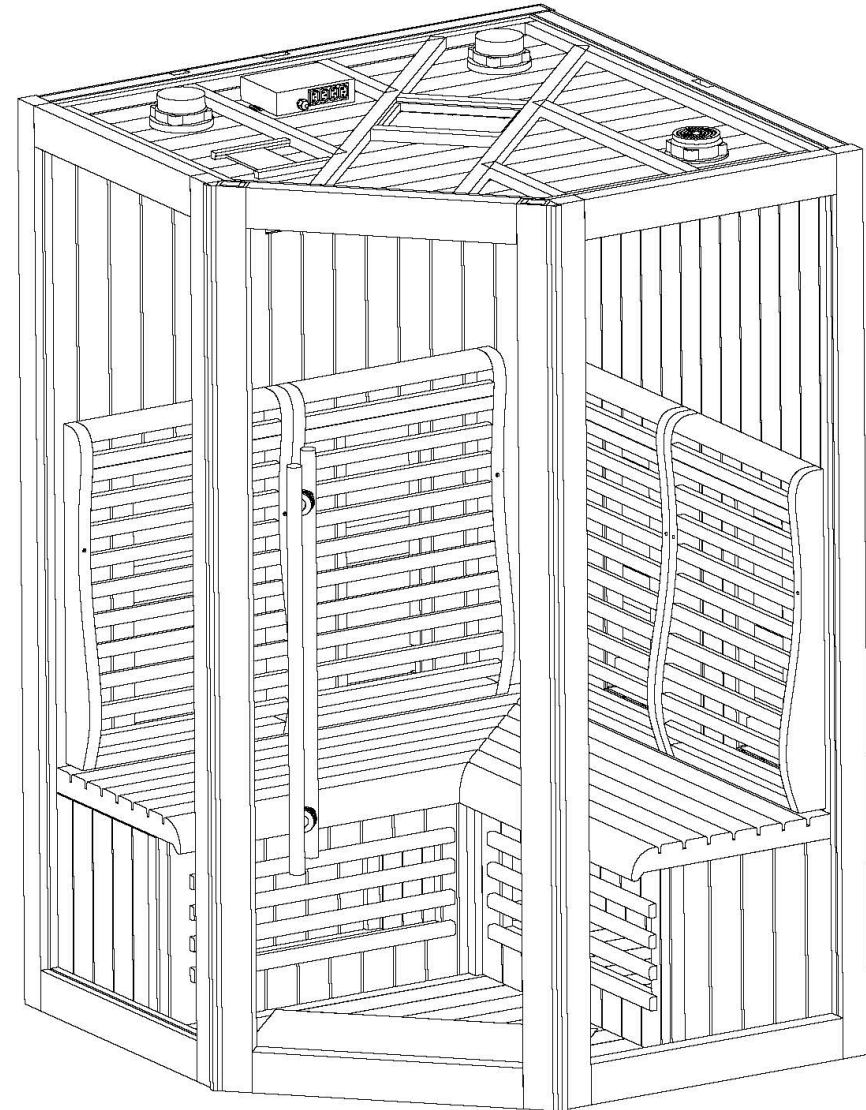

INSTALLATION MANUAL

KY006 Infrared Sauna Series



30 Day Technical Support:

Call **01908 317512** and request technical support for aiding your installation.

Replacements Parts: Inside of your warranty period visit:

<https://www.insigniashowers.com>, click support and make a warranty claim.

Spares/Replacements Parts: Outside of your warranty period visit

<https://www.insigniashowers.com/replacement-parts.html>

ATTENTION INSTALLERS:

These instructions must be left with the customer

CHECK ALL CONTENTS BEFORE BUILD COMMENCES. NO RETURNS CAN BE MADE ONCE THE BUILD HAS STARTED AS IT IS DEEMED ACCEPTANCE OF PRODUCT!

Contents

Thank you for your purchase	3
Electrical & Tool requirements	4
Box contents	5
Screw Pack Contents	6
Sauna Left Panel and Right Panel Install	7
Bench Heater Install	8
Bench Front Panels Install	9
Heater Wires Install	10
Glass Panel Install	11
Bench Seats Install	12

Back Rest Install	13
Door Handles Install	14
Roof Install	15
Connecting the Electrics	16
Securing the Roof	17
Securing the Roof Electrics	18
Electrical Connections	19
Sauna Control Panel Instructions	20
Remote Control Instructions	22
Sauna Room Safety Guide	23
WEEE Compliance Statement	24

*Thank
You*

Thank you for your recent purchase of an Insignia Sauna. Please read this booklet with great care to ensure you get the best out of your build and have a Sauna that will last for many years to come! Like everything, in order to obtain a first class product that will serve you well for many years, the effort and correctness put into the assembly will reflect in the quality of your finish.

Electrical Requirements Model KY006

Voltage Rating 220-240AC
Frequency Rating 50Hz
Power Rating 2469 Watts Sauna
Total Amperage 10.3 amps

Indoor saunas with power consumption under 3KW have been designed for easy installation, allowing for a simple plug-in directly into a standard household power circuit.

Installation Notes:

1. (Recommended) Consult with a qualified Electrician before connection to assess suitability.
2. Ensure all parts are connected safely and correctly.

Always use protection against electrical surges by means of an RCD unit.

If you are uncertain about the installation process or have any questions, please feel free to reach out to our friendly technical support for general advice. For anything more specific to the electric installation, please consult with a certified electrician.

Tools Required

- Scissors
- Knife
- Spirit Level
- Tape Measure
- Philips Screwdriver
- Electric Drill
- Safety Gloves
- Safety Glasses

What's in the Boxes?



Contents	Quantity	
Roof	1	[]
Left Panel	1	[]
Right Panel	1	[]
Left Glass Panel	1	[]
Right Glass Panel	1	[]
Bench Front	2	[]
Bench Top Seat	2	[]



Contents	Quantity	
Door Panel	1	[]
Back Rests	6	[]
Heaters	2	[]
Bench Side Panels	2	[]
Floor Insert	1	[]
Door Handle	2	[]

VERY IMPORTANT

Have you got everything? If not please contact the Insignia directly on **01908 317 512**. Remember **NEVER** book your tradesman until everything has arrived, been checked and is present. No replacement/missing parts can be obtained free of charge during or after the build. Any claims can only be within the timescale permitted (48 hours after delivery) and always **BEFORE** build.

Screw Pack Contents

Contents	Quantity	
ST4*50mm Screws	8	[]
ST5*60mm Screws	10	[]
ST5*70mm Screws	8	[]
ST4*12mm Screws	7	[]
ST4*18mm Screws	8	[]
Wire Fixers	7	[]
Screw Covers	8	[]

VERY IMPORTANT

Have you got everything? If not please contact the Insignia directly on **01908 317 512**. Remember **NEVER** book your tradesman until everything has arrived, been checked and is present. No replacement/missing parts can be obtained free of charge during or after the build. Any claims can only be within the timescale permitted (48 hours after delivery) and always **BEFORE** build.

Step 1 — Installing the Left and Right Panels

The panel connection brackets are shown. Lift panels and locate the interlocking connection brackets and push the panel down to secure into position. Locate both panels onto the wooden side of the base.

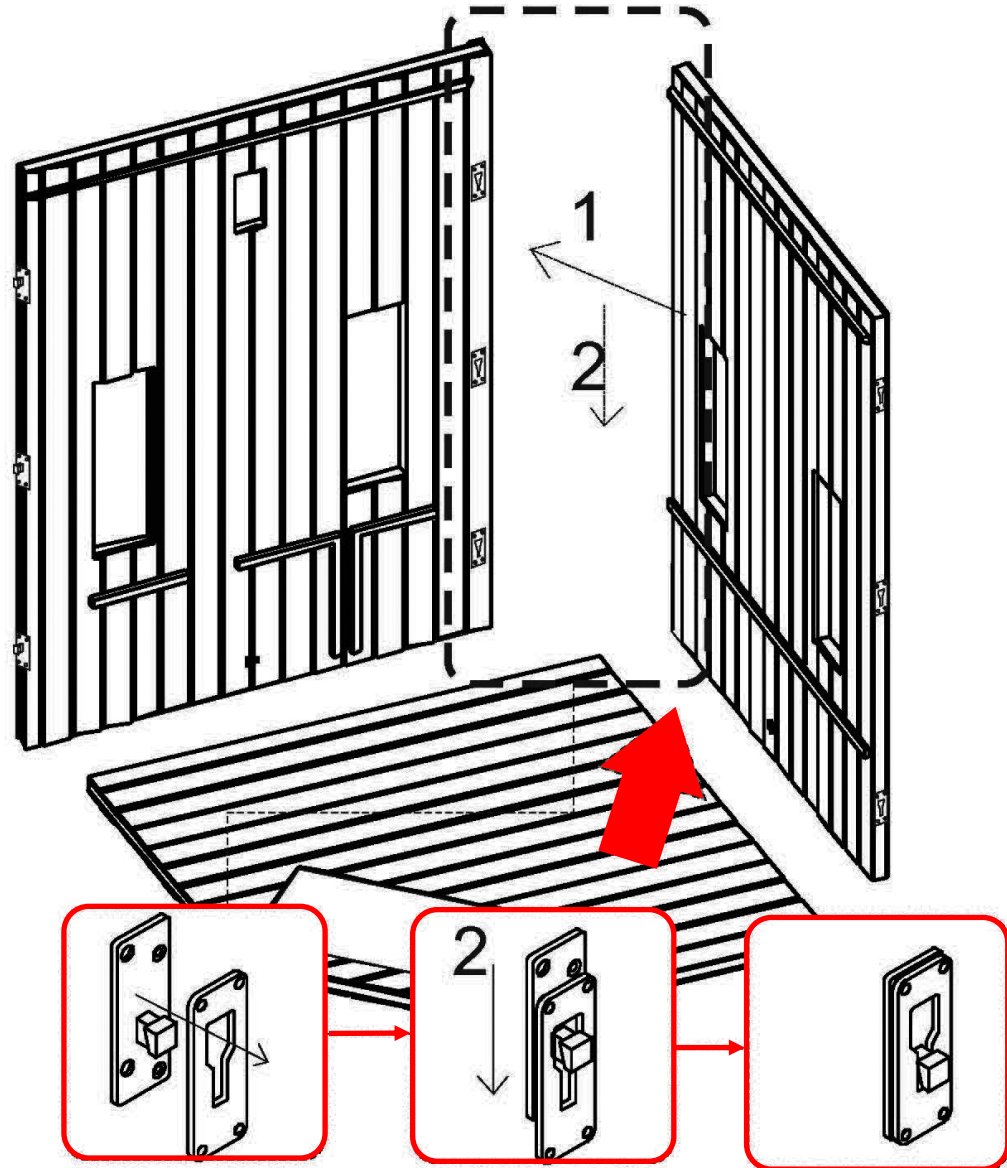

Step 2 — Installing the Bench Heater



4 x ST4*18mm Screws

Using the ST4*18mm screws found in the screw pack, connect the bench heater behind the bench frame as shown in the diagram.

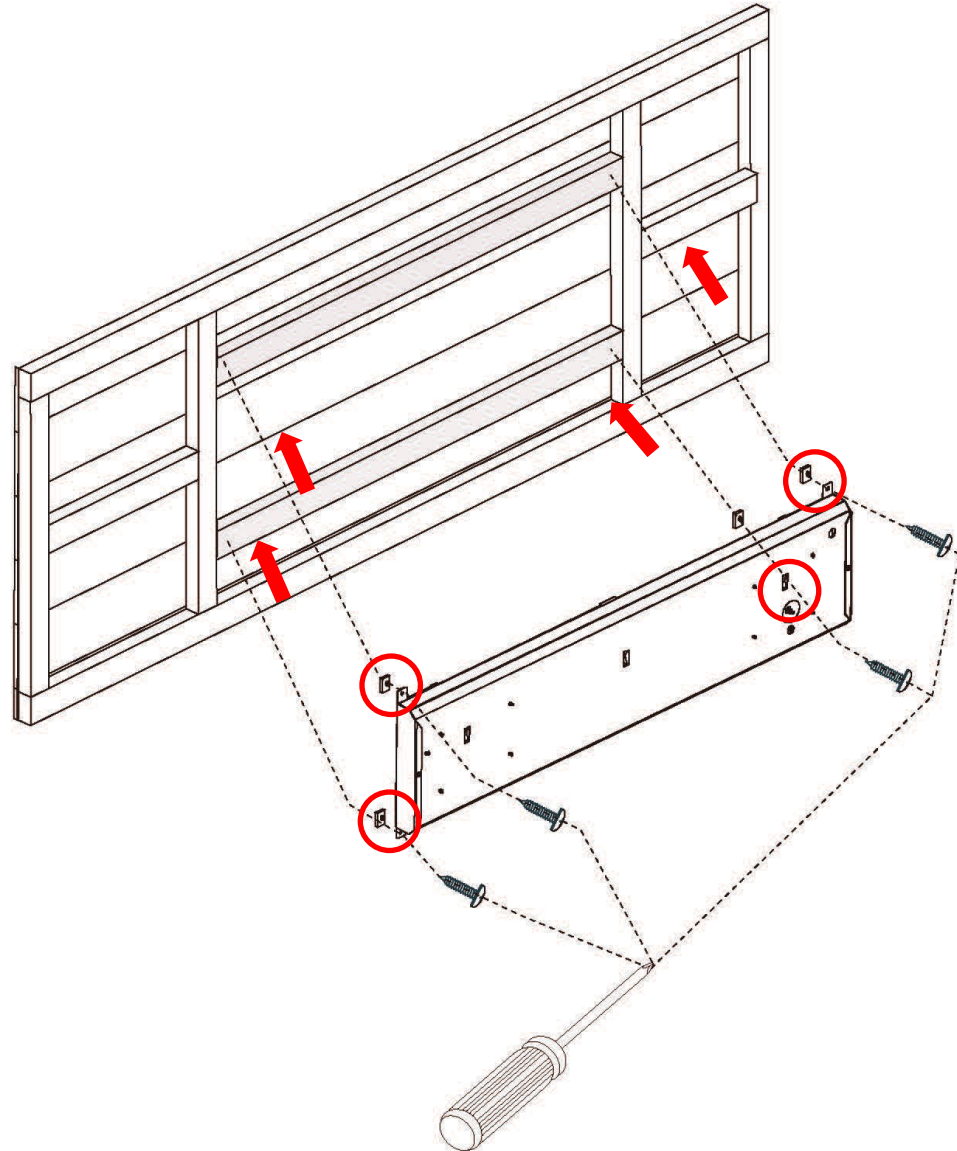

Step 3 — Installing the Bench Front Panel

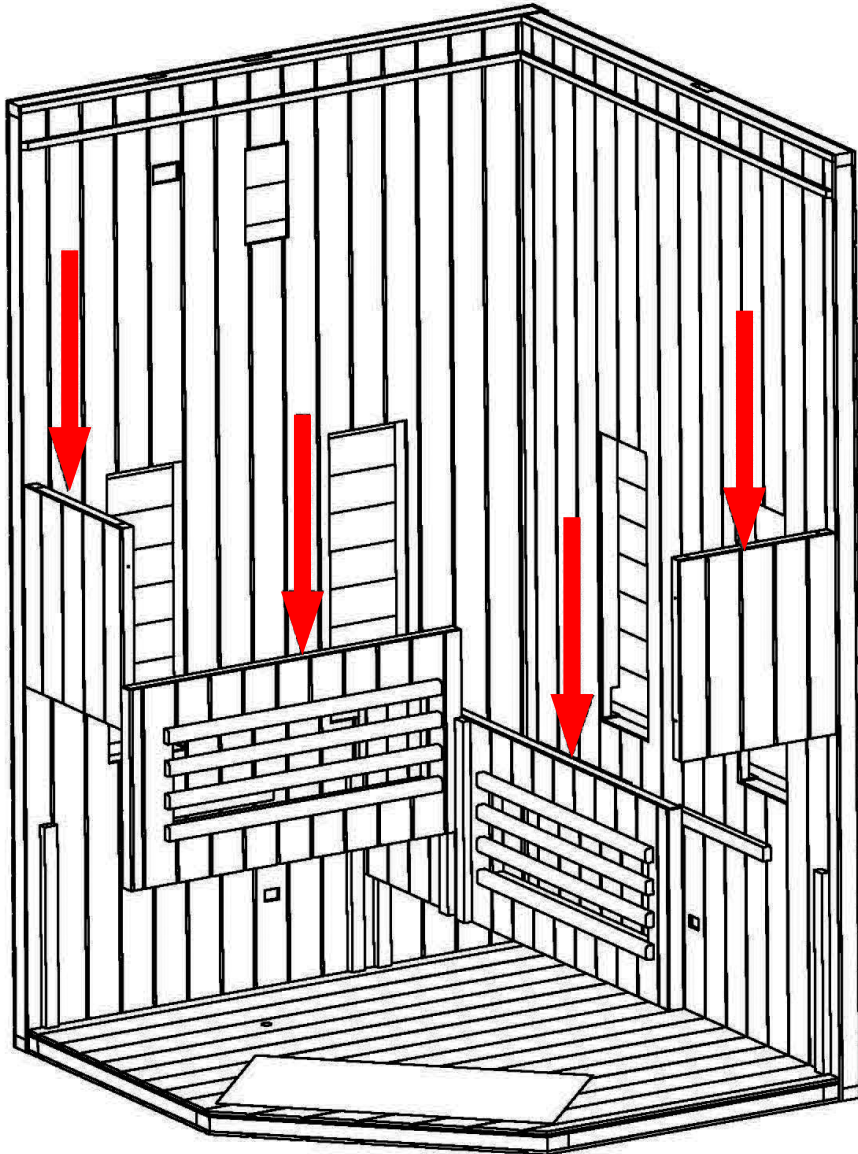

Place the longer bench front into position by sliding into the groove. Next, slide the shorter bench front into the groove. While holding in place, slot the side bench panels securing into the grooves of the bench fronts.

Step 4 — Connecting the Heater Wires

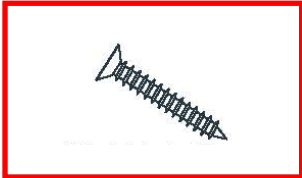

8 x ST4*50mm Screws

Using the ST4*50mm screws, secure the side bench panels in the eight corners.

To connect the wires to the heaters behind the bench panel, locate the black power wire with multiple white wires attached which will connect to the left bench heater. The black power wire with the one white wire will be connected to the right heater. If supplied, secure the earth wire on the back of the heater under the bolt.

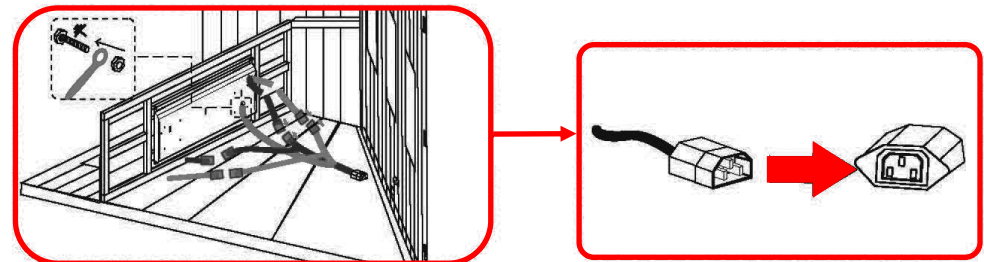
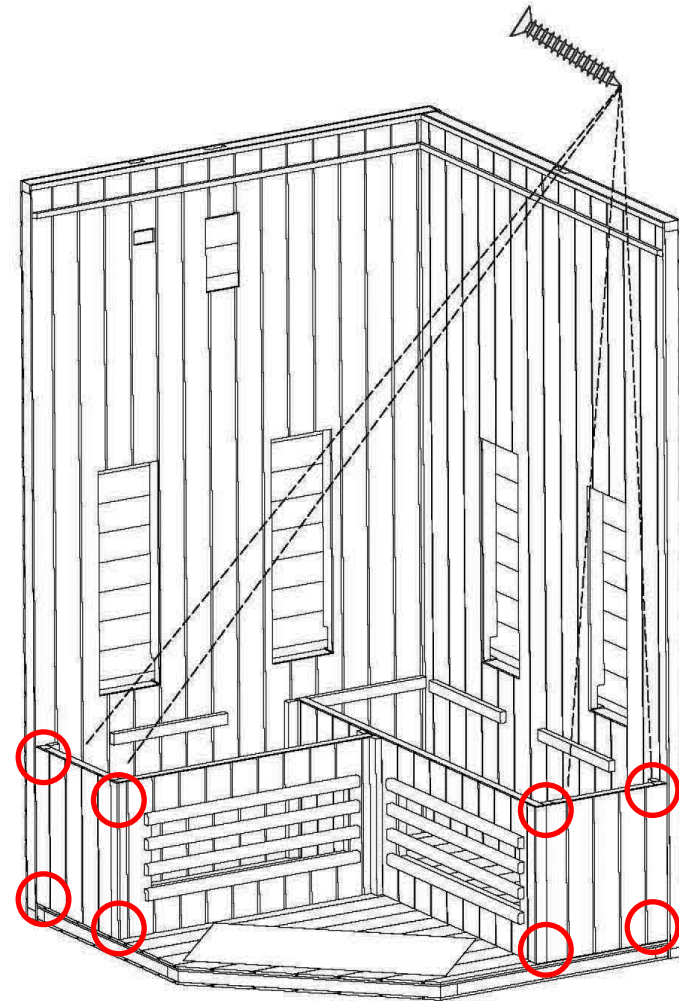

Step 5 — Installing the Bench Seats

Carefully slot the bench tops in place.

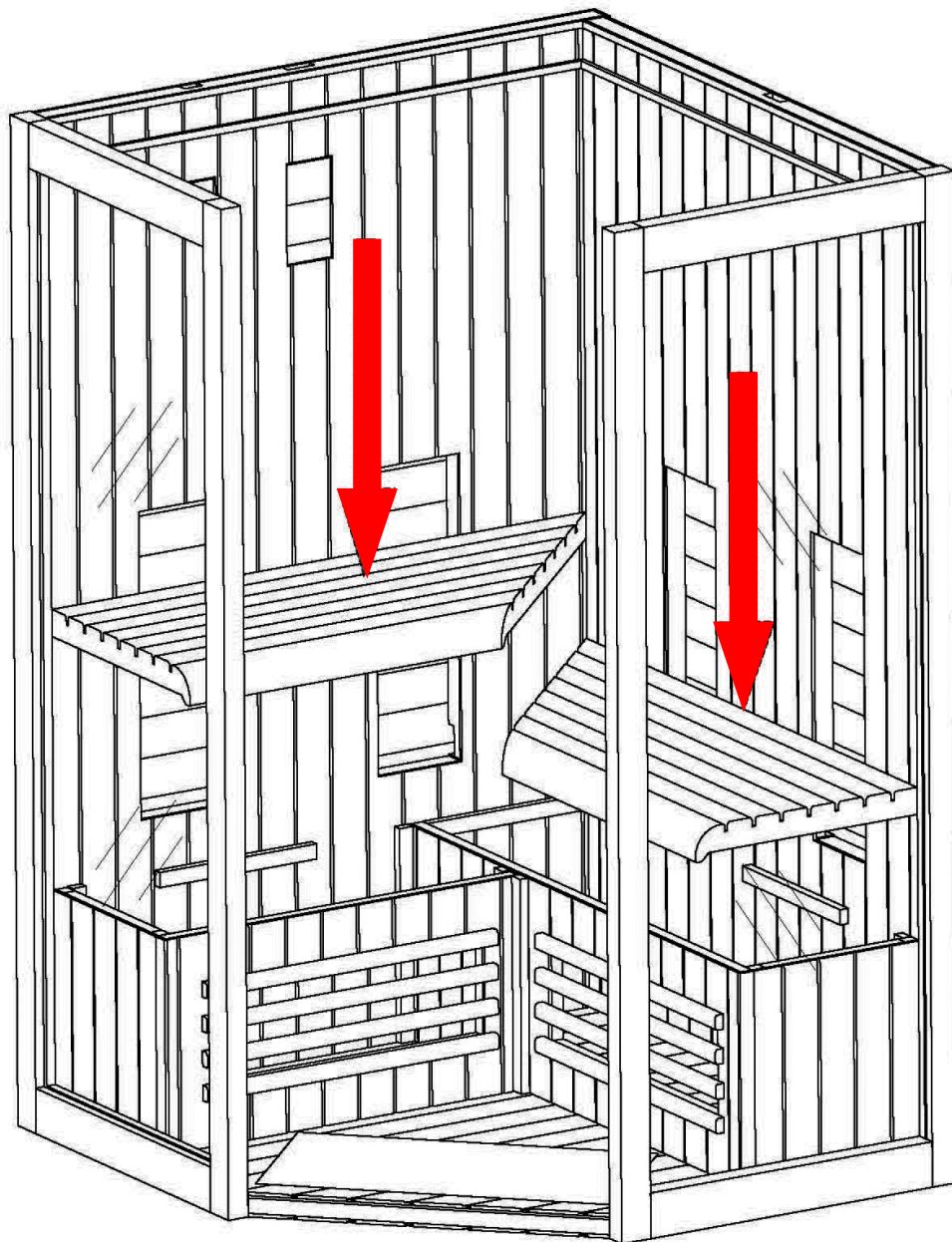

Step 6 — Installing the Glass Panels

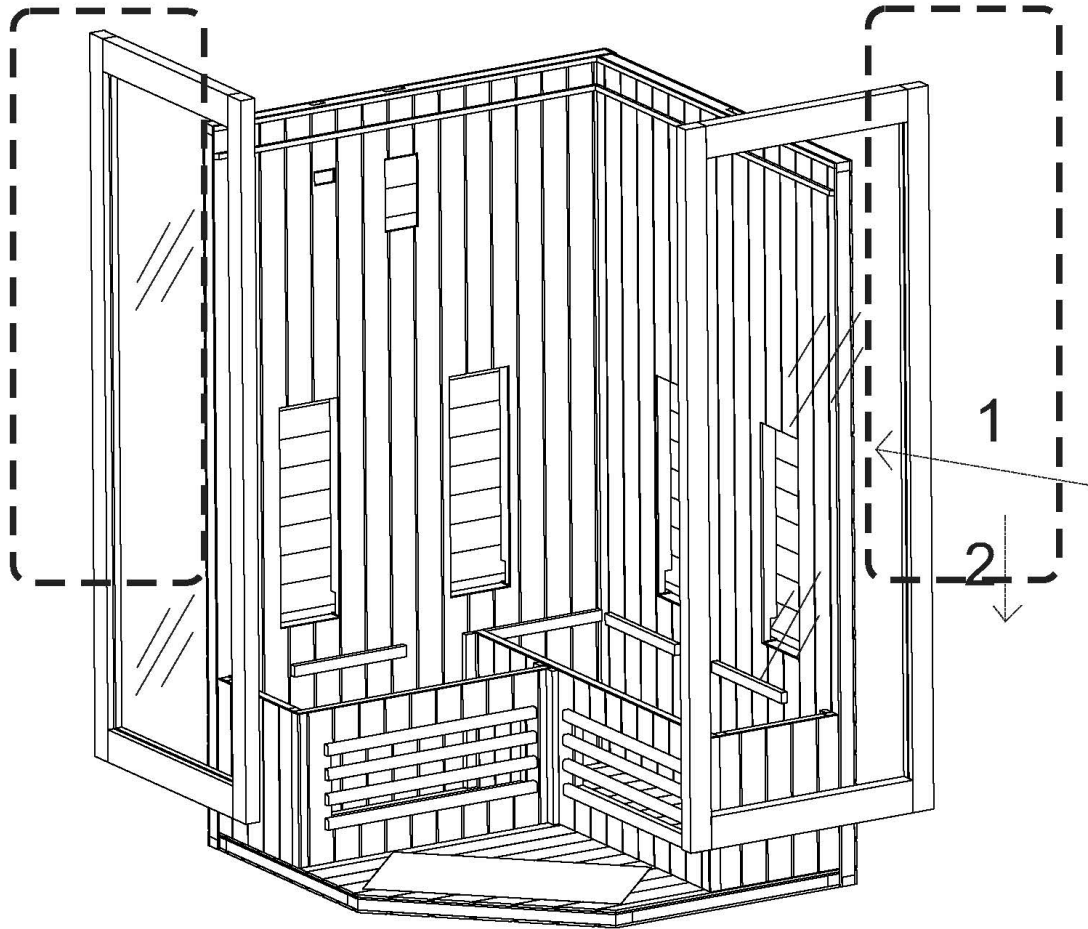

The panel connection brackets are shown. Lift panels and locate the interlocking connection brackets and push the panel down to secure into position.

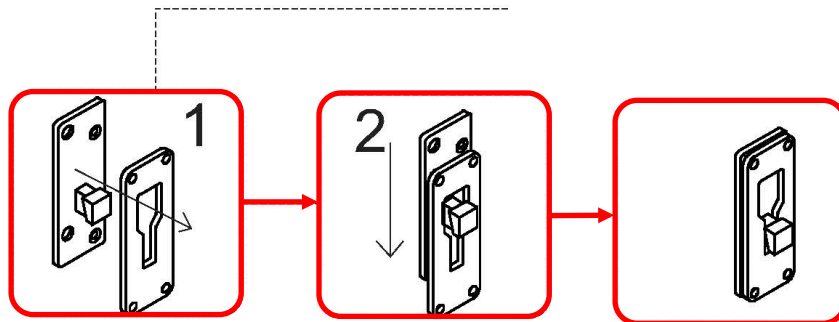

Step 7 — Installing the Back Rests

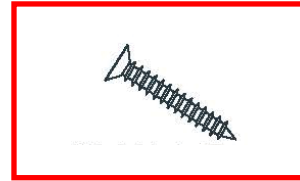

8 x ST5*70mm Screws

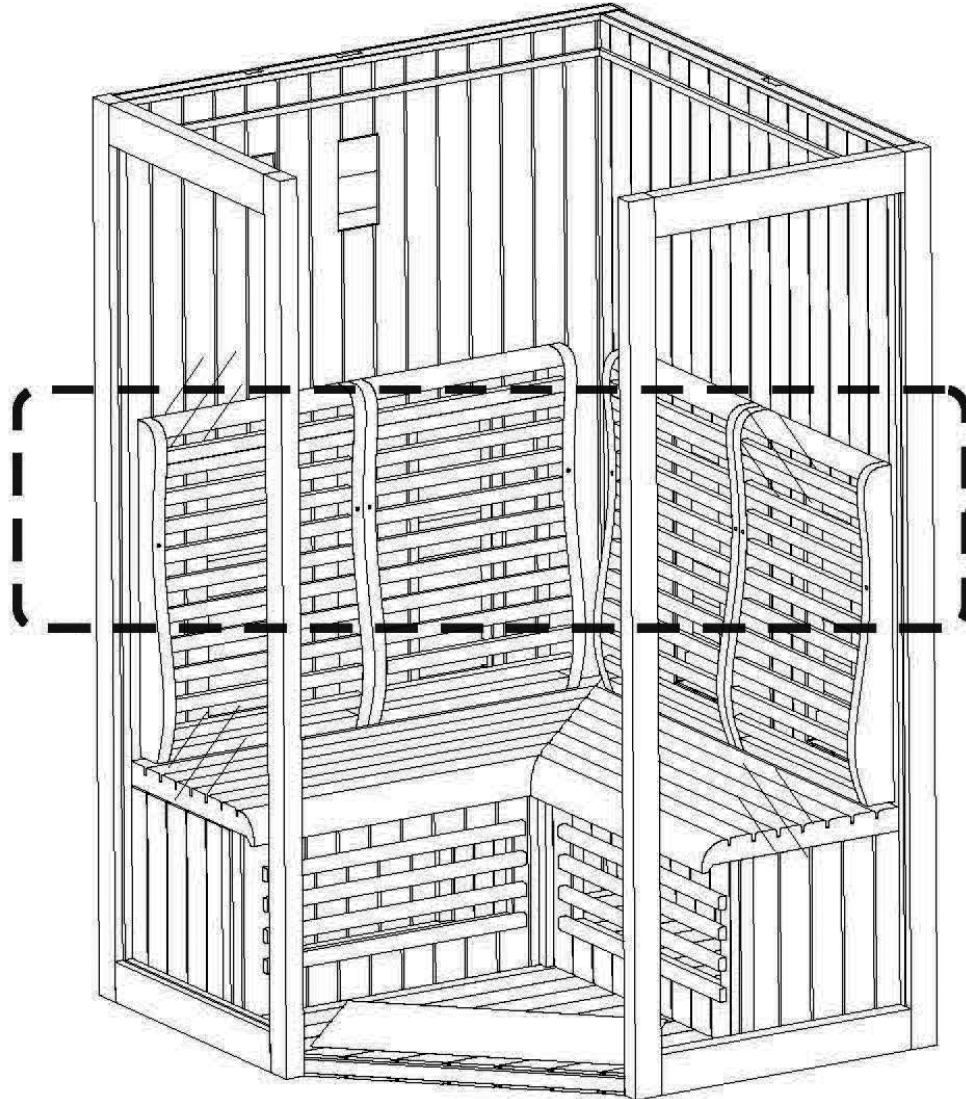

Adjust and align all the 6 back rests in place before screwing using the ST5*70mm screws. Use a drill to screw securely.

Please ensure the protective film is removed from the heaters before covering.

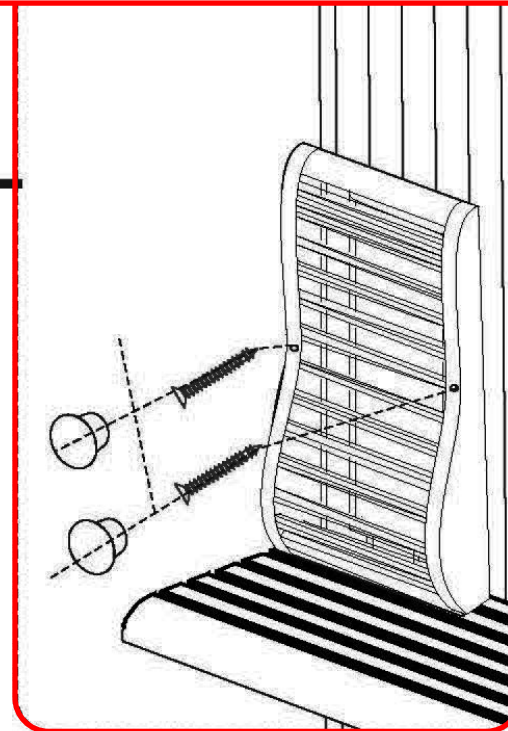

Step 8 — Installing the Door Handles

Taking the door handle screws and nuts apart, remove the thread from the cylinder and tighten the nut within the cylinder to the wooden handle with the larger allen key. Secure with the smaller allen key.

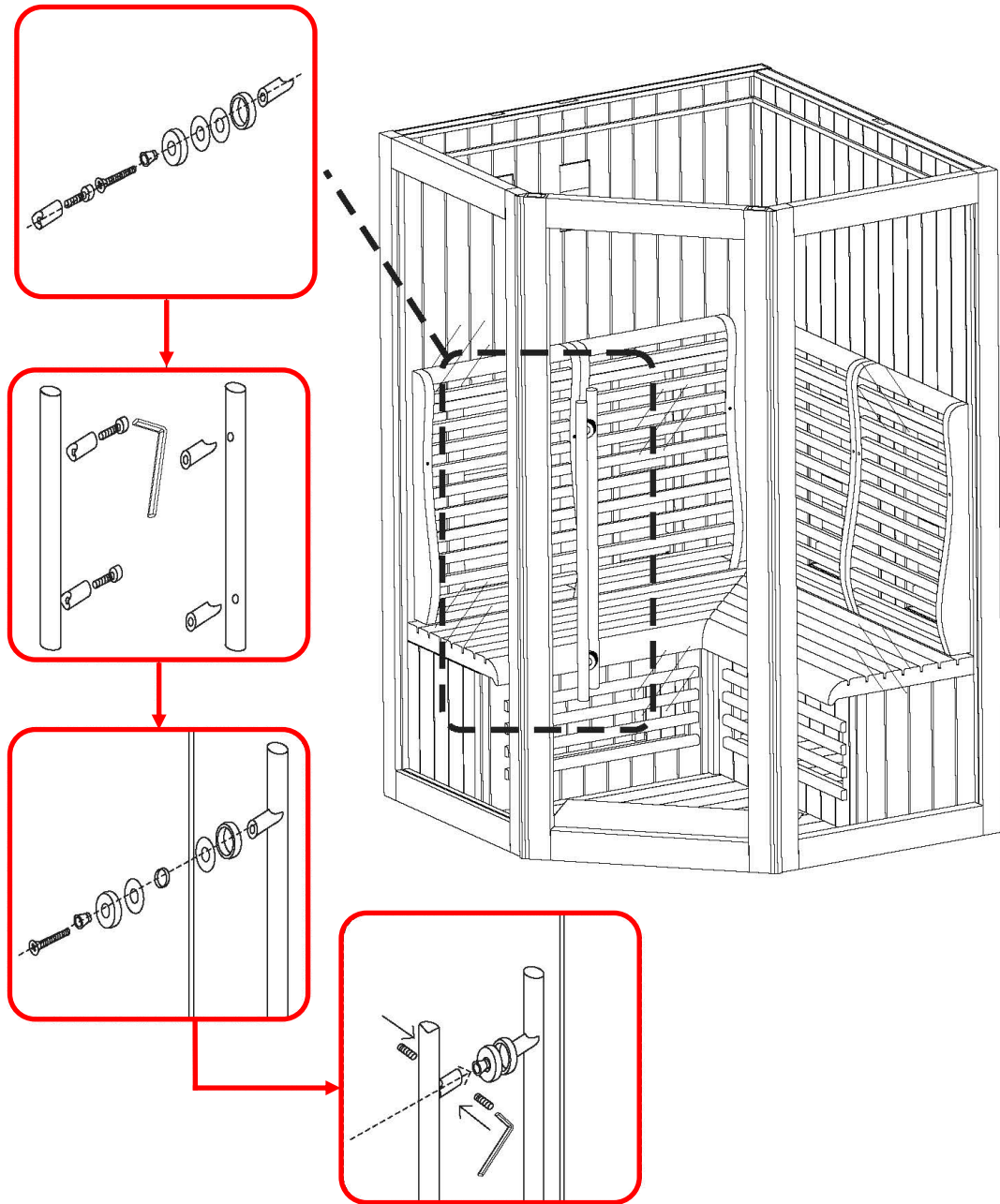

Step 9 — Installing the Roof

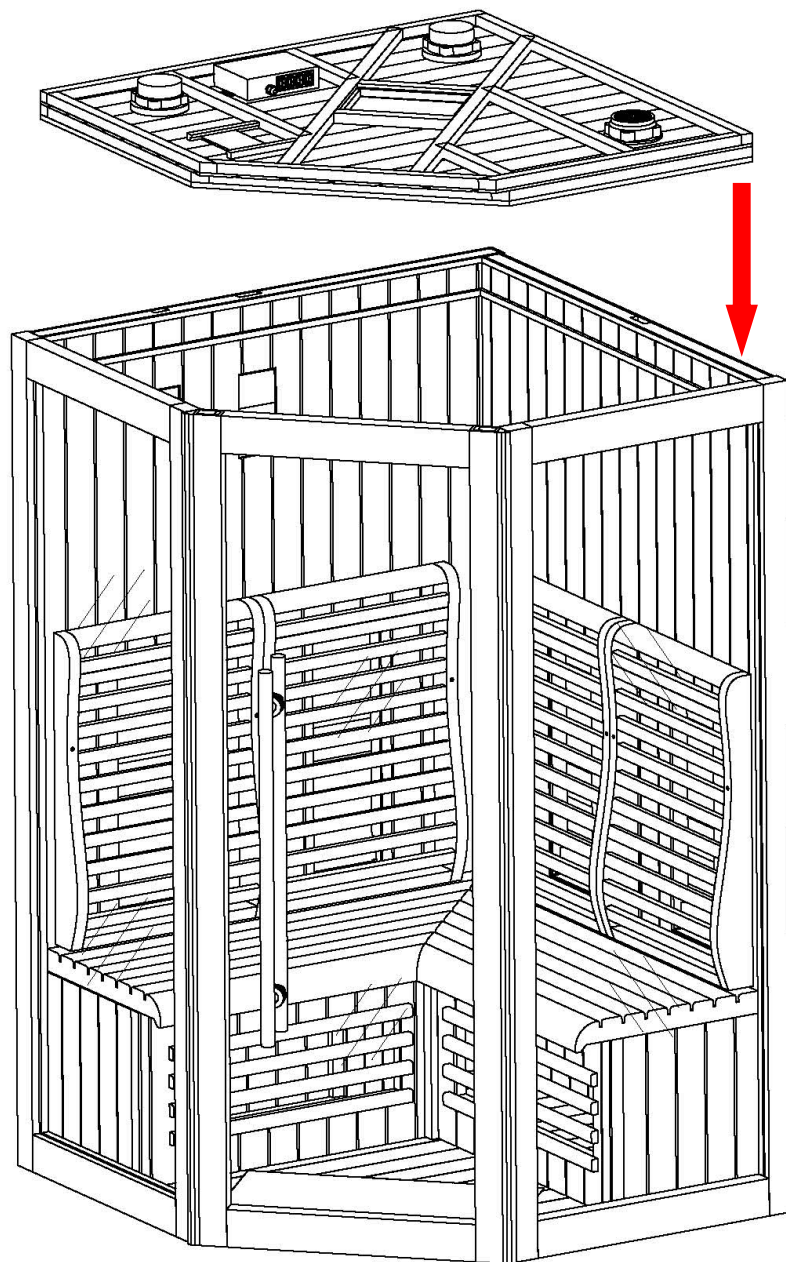

Carefully place the roof into the remaining space making sure it is resting on all sides of the fitted ledges.

Step 10 — Connecting the Electrics

Connect the wires of the main power, control box, temperature control and ozone.

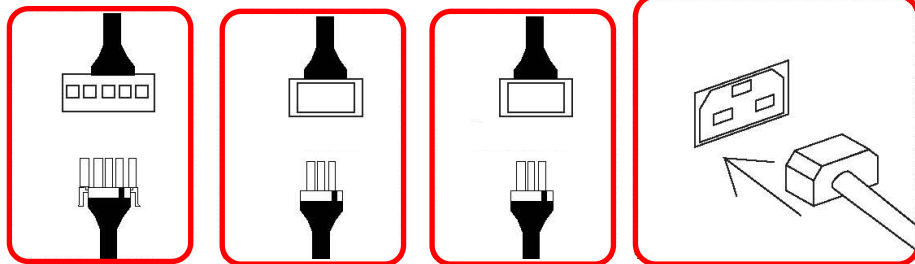
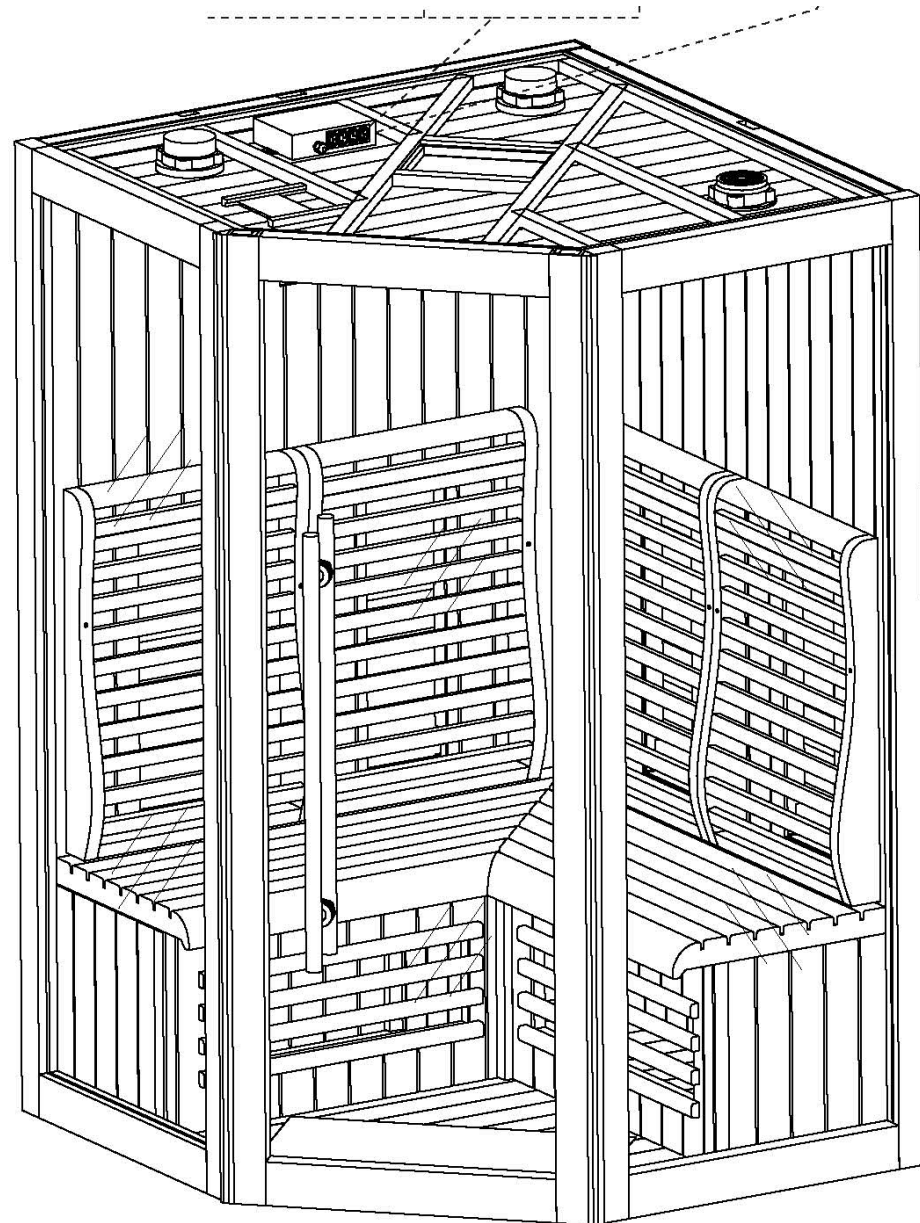

Step 11 — Securing the Roof

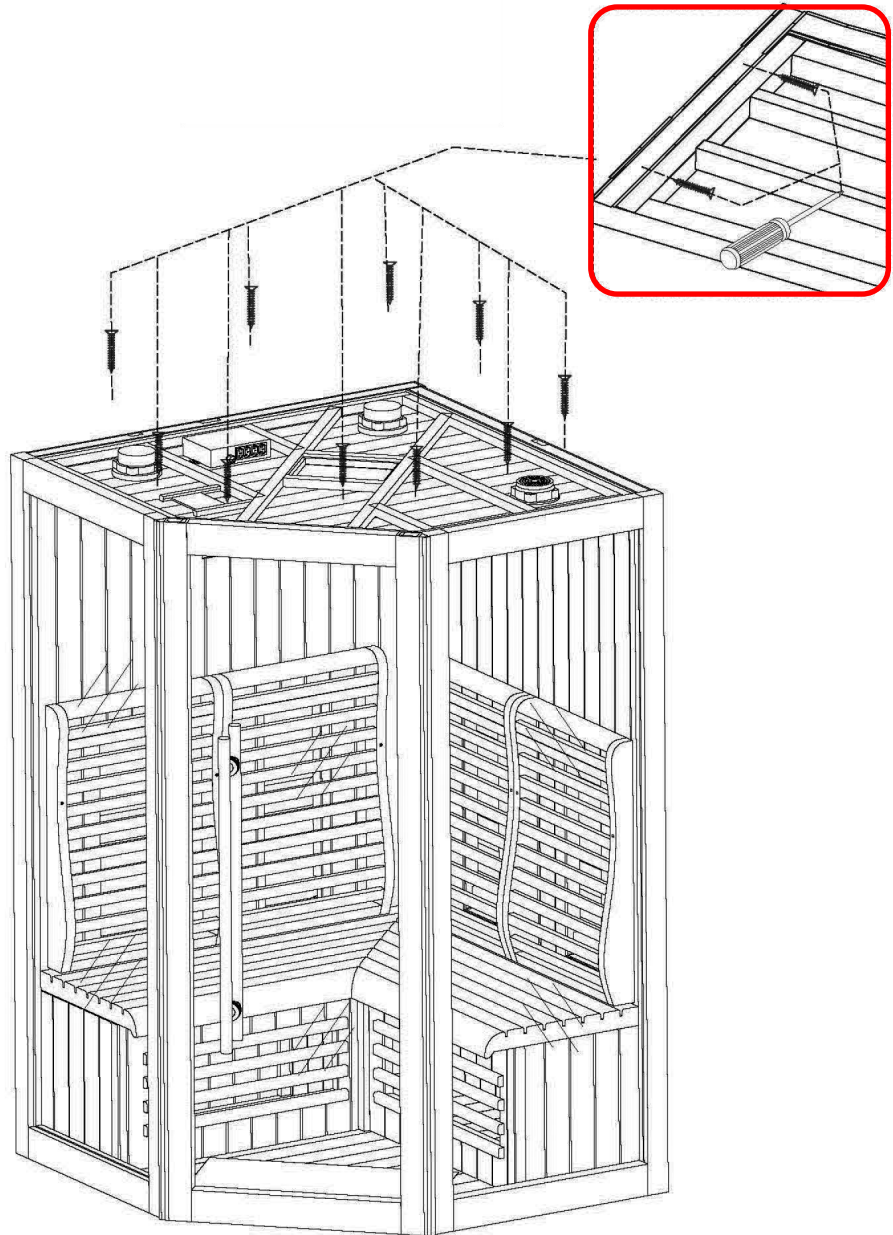

10 x ST5*60mm

Secure the roof by screwing in the ST5*60mm screws.

Step 12 — Securing the Roof Wires

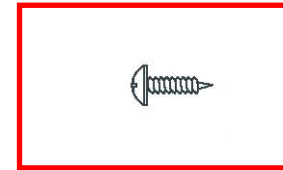
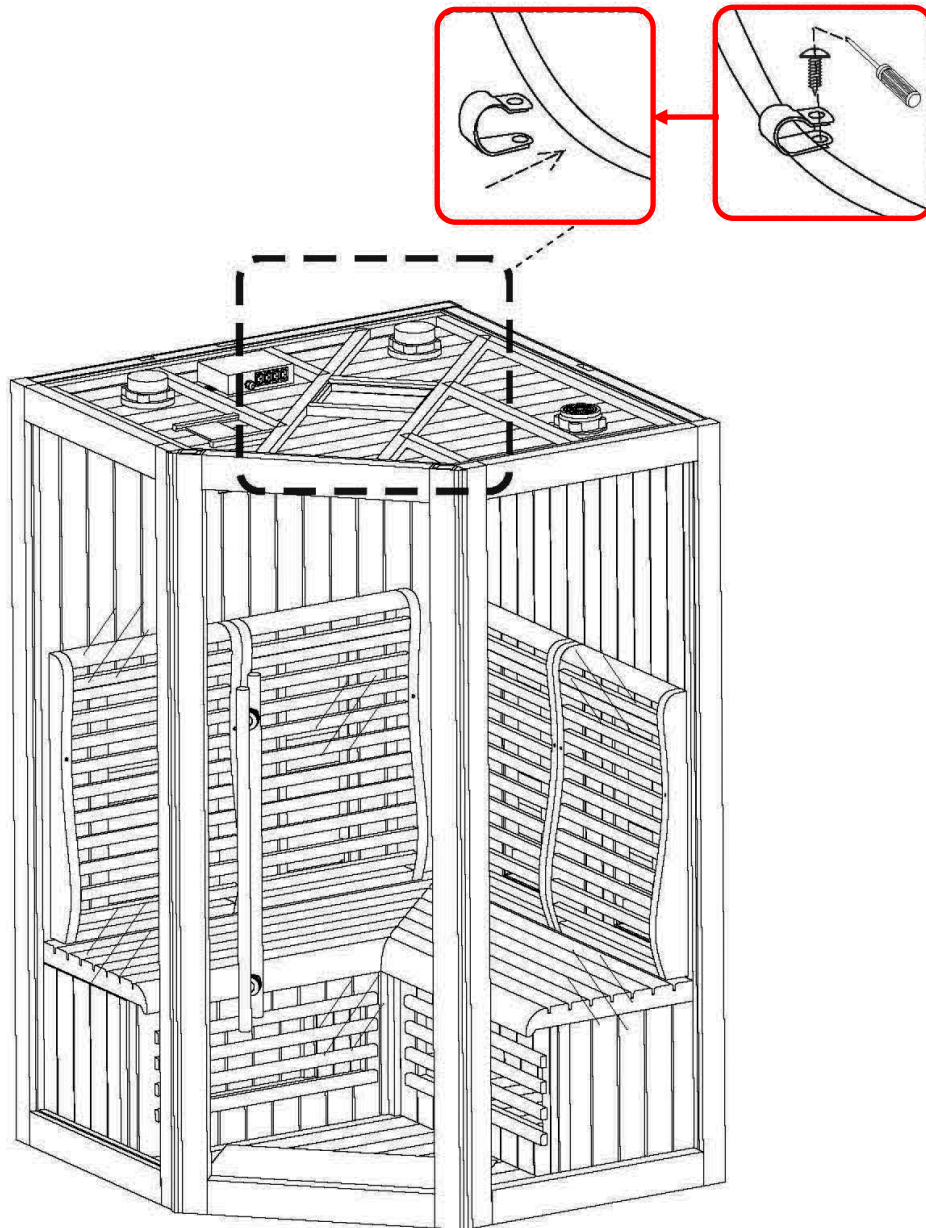

10 x

Use the rubber bands to secure the wires to the roof using the ST4*12mm screws.

Step 12 — Electrical Connections

1. Main Power Supply
2. Group A : Connections for back and leg heater
3. Group B : Connections for front and side heater
4. Temperature Detector Wire
5. USB Input
6. Temperature Controller Wire
7. Antenna
8. Speaker Wires
9. Fan Wire
10. Ozone
11. Roof Light
12. CD/MP3 Wire
13. Control Panel Wire
14. AC220V Power Cord
15. Chromatherapy Lighting

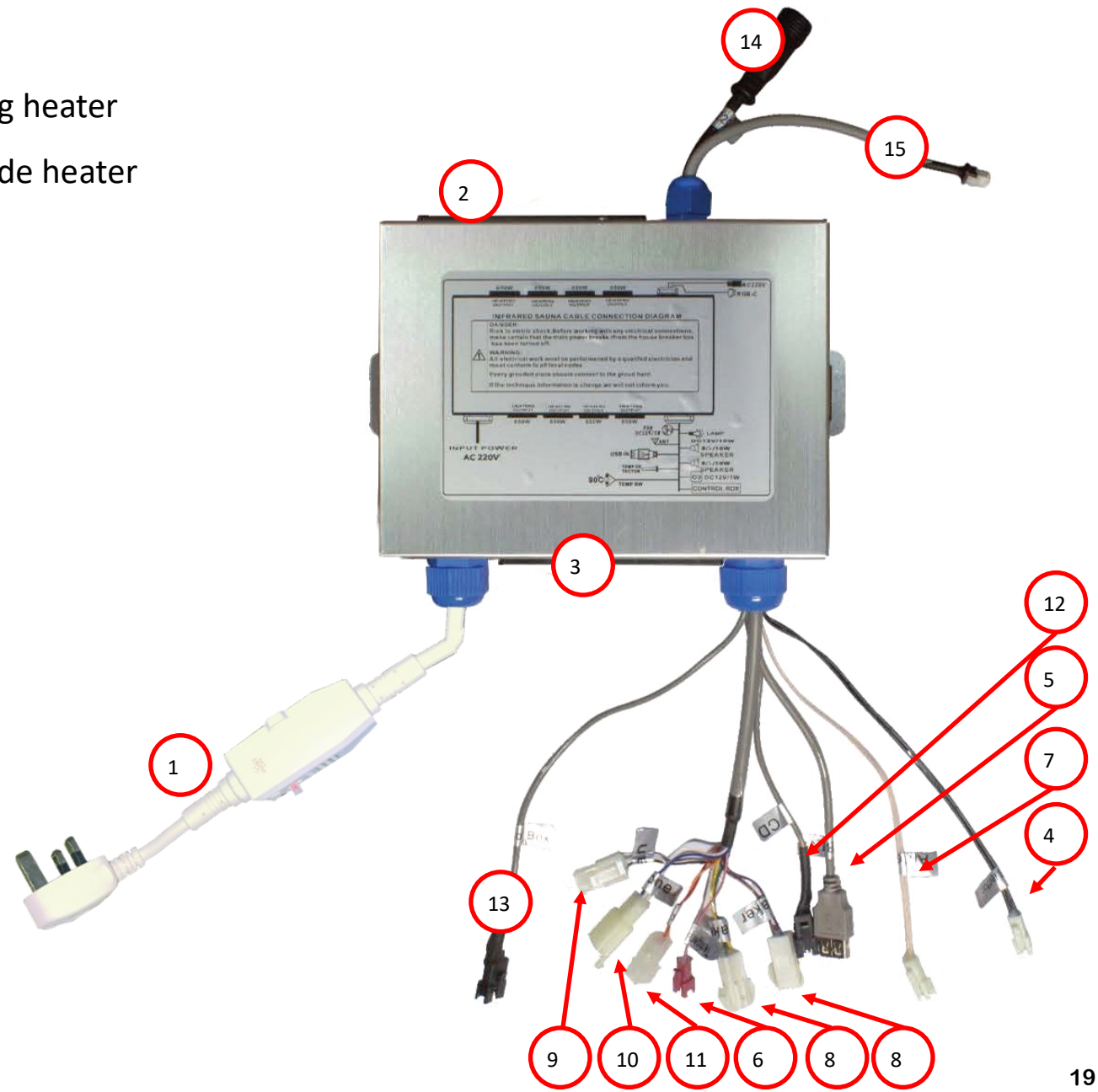

Control Panel Instructions

Button 1/2 (Sauna Heaters)

Press to activate Sauna heaters. Pressing once will put the heaters on at 100%. Twice = 90%. Three times = 80%. Four times = 70% and five times = Off.

Button 3(Lights)

Press to cycle through the coloured lights. Each press will change colour until a full cycle is completed and they turn off.

Button 4 (Fan)

Press to turn the fan on, press again to turn it to auto and then a third time to turn it off.

Button 5 (Time/Temp)

Press to display temp, then cycle through desired temperature setting (max 60°C) using up and down arrows (Buttons 6/8). Press again to display time, then cycle through desired time setting (max 99 mins) using up and down arrows (Buttons 6/8).

Button 6/8 (Up and Down Arrows)

Use to cycle up or down through various setting options. As standard these operate the volume until other settings are activated.

Button 7 (Play/Pause/Memory)

Use to Play/Pause music through various settings. When searching and tuning the radio, use to save a desired frequency to a specific channel.

Button 9 (Set)

Press and use the arrows (Button 5/11) to manually search. Hold to tune radio stations automatically.

Button 10 (Audio Mode)

Press to cycle through the audio options, Radio/MP3/USB/Bluetooth or AUX.

Button 11 (Alarm)

Press to activate the alarm, press again to deactivate it. Activating the alarm will cause all sauna heaters to automatically turn off.

Button 12 (Power)

Use to power the control panel on or off. Also use to unlock the panel (enters lock mode automatically after 60 seconds of inactivity).

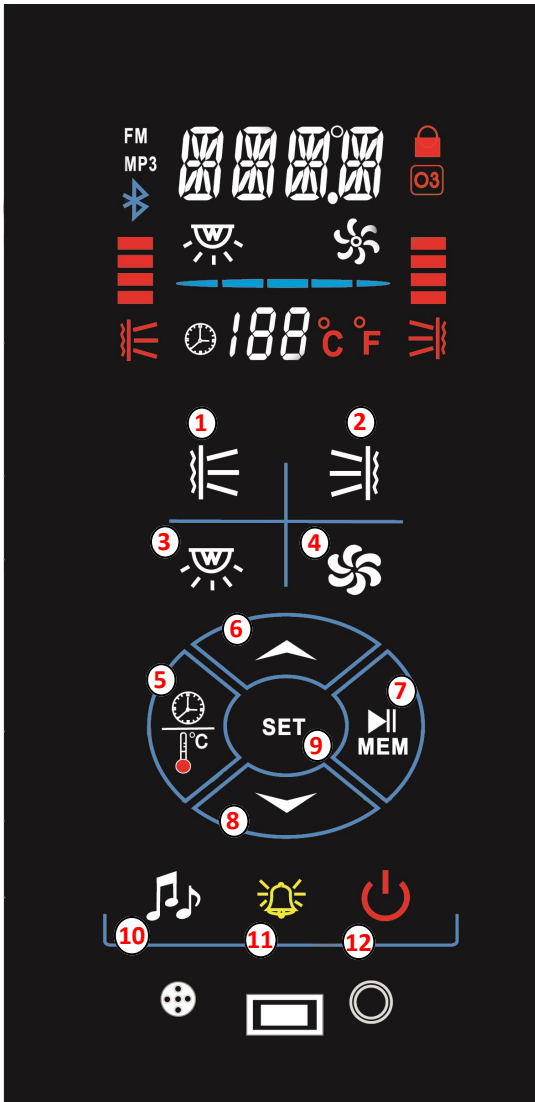

Audio Functions

Radio Tuning:

To tune the Radio hold 'SET' for two seconds to activate the menus. Press 'SET' to bring up manual tuning. Use the arrows to tune to your preferred station. To fast scroll hold the up or down arrow for two seconds. Alternatively, press 'SET' again to activate auto tuning then press the 'Play/Pause' button to begin scrolling.

Bluetooth Connection:

To connect the Bluetooth, press the audio function button a few times until you see the 'bt' menu. Now ensure your device Bluetooth is on and search. Pair with your Sauna and once connection has been made successfully you will be notified by a connection tone and the Bluetooth symbol will appear on the control panel interface. In order to change track, press 'SET' and then use the up and down arrows accordingly.

USB:

Plug your USB device in and press the audio function until you get to the MP3/USB setting. The audio tracks will start to play automatically. In order to change track, press 'SET' and then use the up and down arrows accordingly.



Remote Control Instructions

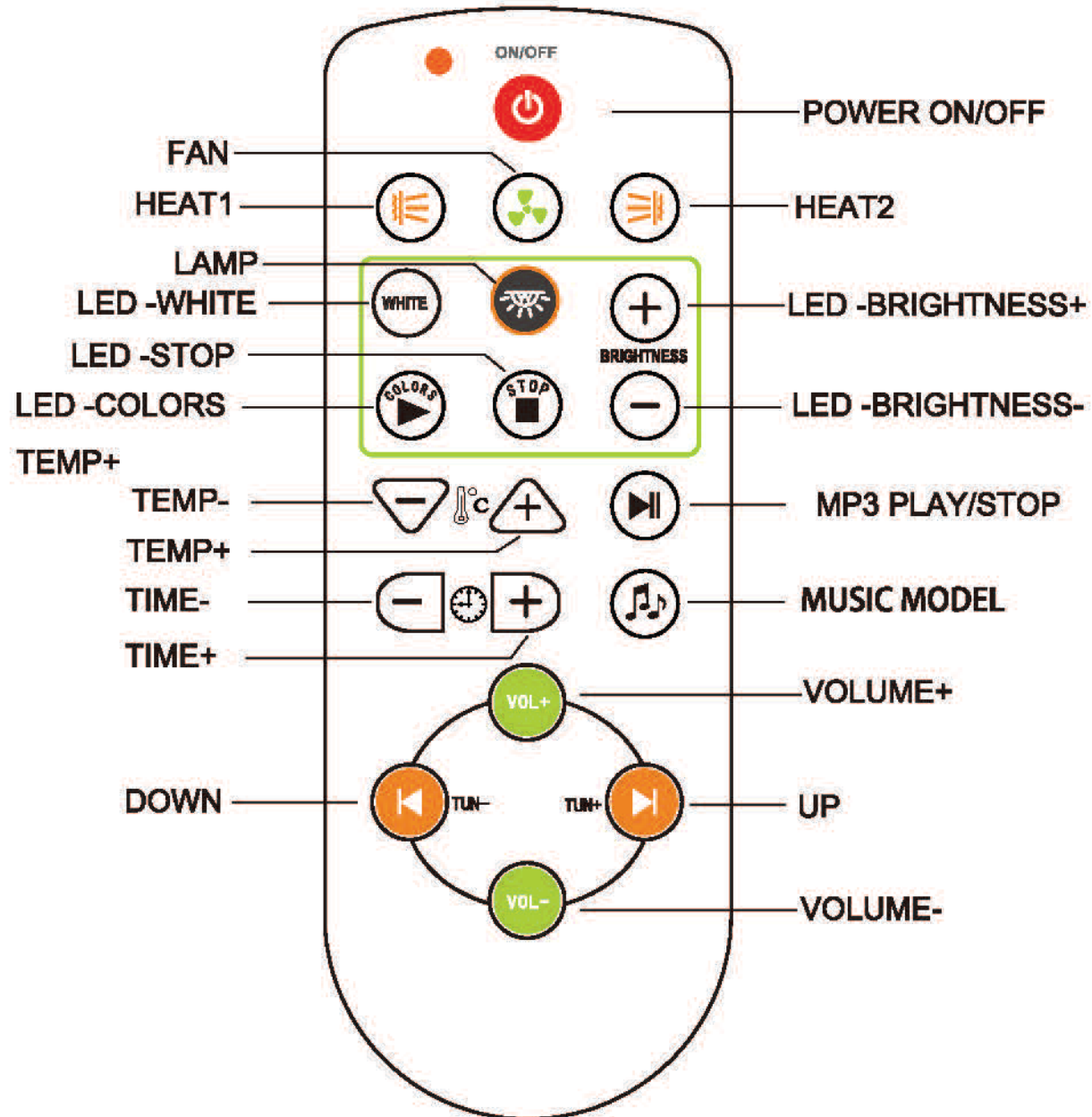

Sauna Usage & Safety Guide

1. Never leave children unattended in the Sauna.
2. Regulate (if preferred) the temperature of sauna before session - Pre-heat time 15-30 minutes (from room temperature 20c)
3. Never touch the heater panels whilst in operation, possible burning may occur.
4. Recommended time of use is a maximum of 15 mins initially. We highly recommend working up in time to this, beginning with 5 minute sessions to get your body used to using a sauna.
5. Suggested operational heat range: Infrared—30° C-40° C. Infrared optimum use range 35°C to 40°C
6. Stay hydrated during each sauna session.
7. Exit the sauna immediately if feeling dizzy, faint or short of breath.
8. Do NOT use the sauna function if you're pregnant, have a heart condition, have low or high blood pressure. If you're unsure consult your GP before use.
9. If you have any underlying health conditions which you feel could be aggravated by an increase in temperature, consult your GP before use.
10. If you begin to have any issues with your health after using a sauna, stop immediately and consult your GP regarding your symptoms before continuing to use.
11. Consult your GP before using the steam room if you're on medication at all, especially with drowsy side effects.
12. Never use the sauna if you have been drinking alcohol or under the influence of other substances.
13. Do not put combustible material on the heaters at any time.
14. Always turn power supply off after use.

WEEE Compliance Statement

The UK Waste Electrical and Electronic Equipment (WEEE) regulations came into force on 2 January 2007. Under this new legislation, producers of electrical and electronic equipment (EEE) have to fulfil certain obligations.

Under the WEEE directive Insignia is considered the producer of certain products we supply and in line with the demands of the legislation we are pleased to offer the opportunity to return these products to us for treatment and recycling.

Insignia products will generally have an identifying mark and the common crossed out wheelie bin label. We accept returns of all products carrying the Insignia brand. All other products are either considered outside the scope of WEEE or Insignia is not technically the producer of these products. Insignia also accepts historic like-for-like WEEE returns. All WEEE returned to Insignia will be recycled in appropriate treatment and recycling centres in accordance with the legislation. If you wish to return any products to us, please send your item(s) to our head office.

Company Contract No. 326457

WEEE Producer No. CBDU64227

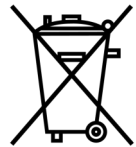

LABELLING

Products labelled with the WEEE symbol (a crossed out “waste bin”) indicate that the final user should not discard this product along with other household waste, but that it must be collected and treated separately.



Returns Address for WEEE

Insignia

9a Deans Road, Old Wolverton, Canon Industrial Park, Milton Keynes, Buckinghamshire, MK12 5NA, UK



EU – Declaration of Performance

Insignia declares that all its products complies with the essential requirements and other relevant provisions of Directive 305/2011/EC. A copy of the Declaration of performance is available from www.insigniashowers.com/ce-certification

Insignia™ is a registered trademark of Maclean International Ltd, 9a Deans Road, Old Wolverton, Canon Industrial Park, Milton Keynes, Buckinghamshire, MK12 5NA, UK

All images are subject to copyright. Images may not be used in any way shape or form with out written permission from Maclean International Ltd. Images are NOT permitted to be saved, printed or uploaded. Violation of copyright laws are punishable by law.

All images are registered with
ImageTraker

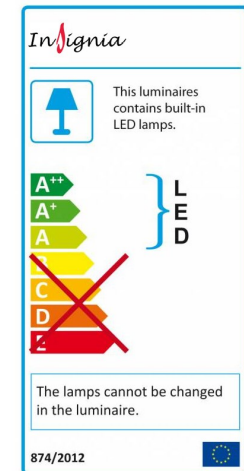

Insignia™ is a registered trademark of Maclean International Ltd

All images are subject to copyright. Images may not be used in any way shape or form with out written permission from Maclean International Ltd. Images are NOT permitted to be saved, printed or uploaded. Violation of copyright laws are punishable by law.