



## INSTALLATION MANUAL

KYS2000a

Sauna Series



**30 Day Technical Support:**

Call **01908 317512** and request technical support for aiding your installation.

**Replacements Parts:** Inside of your warranty period visit:

<https://www.insigniashowers.com>, click support and make a warranty claim.

**Spares/Replacements Parts:** Outside of your warranty period visit

<https://www.insigniashowers.com/replacement-parts.html>

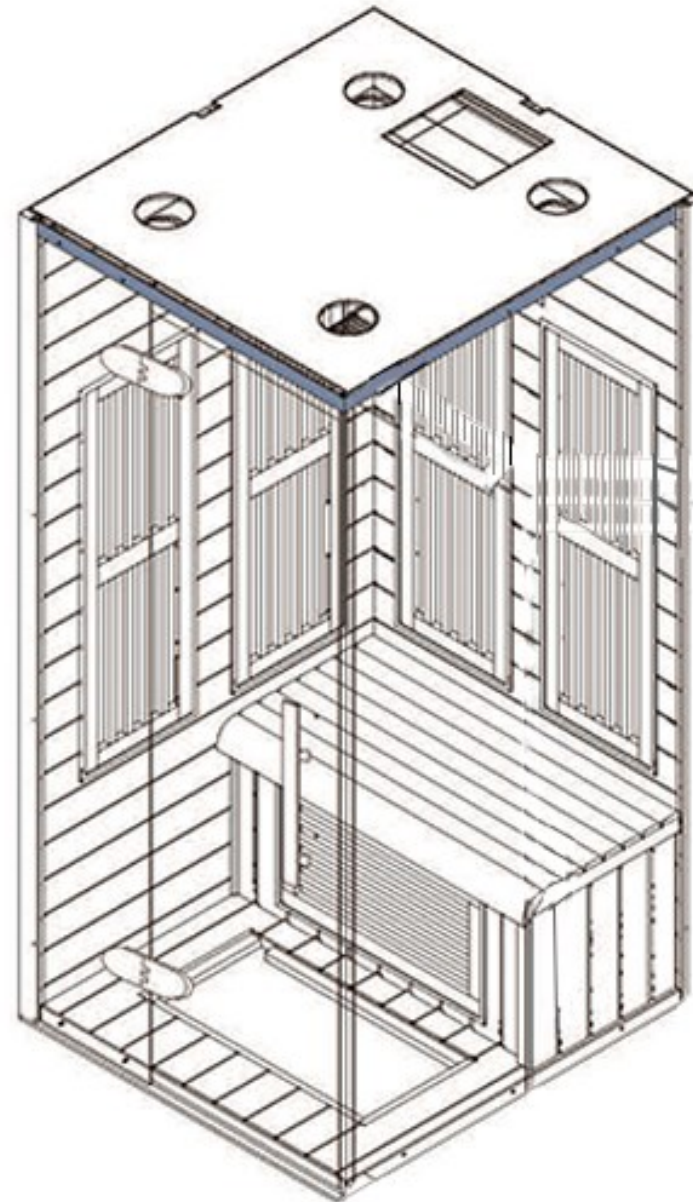

ATTENTION INSTALLERS:

These instructions must be left with the customer

**CHECK ALL CONTENTS BEFORE BUILD COMMENCES. NO RETURNS CAN BE MADE ONCE THE BUILD HAS STARTED AS IT IS DEEMED ACCEPTANCE OF PRODUCT!**

## Contents

Thank you for your purchase	3
Electrical & Tool requirements	4
Box contents	5
Sauna Side Panel and Back Panel Install	6
Floor Placement	7
Bench Install	8
Bench Electrics Connection	9
Bench Seat Install	10
Central Glass Partition Install	11
Fixed Glass Panel Install (Sauna)	12
Roof Install	13
Central Upright Connection	14
Door Install (Sauna)	15
Door Handle Install (Sauna)	16
Roof Cover Install	17

Sauna Control Panel Instructions	18
Sauna Room Safety Guide	19
WEEE Compliance Statement	20

*Thank  
You*

Thank you for your recent purchase of an Insignia Sauna. Please read this booklet with great care to ensure you get the best out of your build and have a Sauna that will last for many years to come! Like everything, in order to obtain a first class product that will serve you well for many years, the effort and correctness put into the assembly will reflect in the quality of your finish.

## Electrical Requirements Model KYS2000a

Voltage Rating 220-240AC

Frequency Rating 50Hz

Power Rating 1597 Watts

Total Amperage 6.7 Amps

Indoor saunas with power consumption under 3KW have been designed for easy installation, allowing for a simple plug-in directly into a standard household power circuit.

### Installation Notes:

1. (Recommended) Consult with a qualified Electrician before connection to assess suitability.
2. Ensure all parts are connected safely and correctly.

**NOTE: Saunas built in a bathroom must meet UK bathroom regulations and should be installed by a qualified electrician.**

**Always** use protection against electrical surges by means of an RCD unit.

If you are uncertain about the installation process or have any questions, please feel free to reach out to our friendly technical support for general advice. For anything more specific to the electric installation, please consult with a certified electrician.

Subject to connection type, electrical work needs to be signed off by a fully qualified operative by law. Failure to adhere to this will not only void your electrical warranty for your sauna, but could void your house insurance

## Tools Required

- Scissors
- Knife
- Spirit Level
- Tape Measure
- Philips Screwdriver
- Electric Drill
- Safety Gloves
- Safety Glasses

## What's in the Boxes?

Contents	Quantity	✓
Roof	1	[ ]
Floor	1	[ ]
Middle Partition Glass Panel	1	[ ]
Wooden Side Panel	1	[ ]
Wooden Back Panel	1	[ ]
Accessories	1	[ ]
Door Handle	1	[ ]
Door Hinge	4	[ ]
Sauna Door	1	[ ]
Central Upright Connector	1	[ ]
Magnetic Seal	4	[ ]
Rear Door Seal	2	[ ]

Contents	Quantity	✓
Bench Top	1	[ ]
Bench Side	1	[ ]
Bench Front	1	[ ]

### VERY IMPORTANT

Have you got everything? If not please contact the Insignia directly on **01908 317 512**. Remember **NEVER** book your tradesman until everything has arrived, been checked and is present. No replacement/missing parts can be obtained free of charge during or after the build. Any claims can only be within the timescale permitted (48 hours after delivery) and always **BEFORE** build.

## Step 1 — Installing the back and side panel (Sauna)

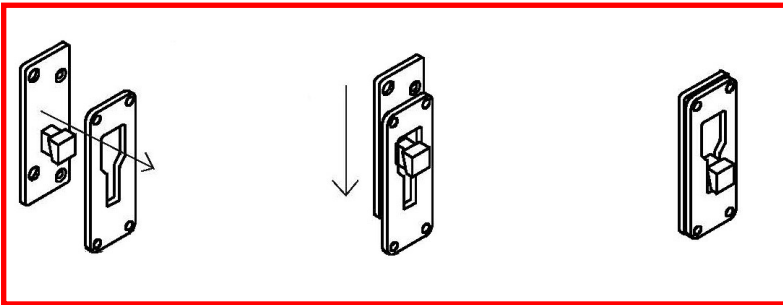

The panel connection brackets are shown (above). Lift panels and locate the interlocking connection brackets and push the panel down to secure into position. Locate both panels onto the wooden side of the base.

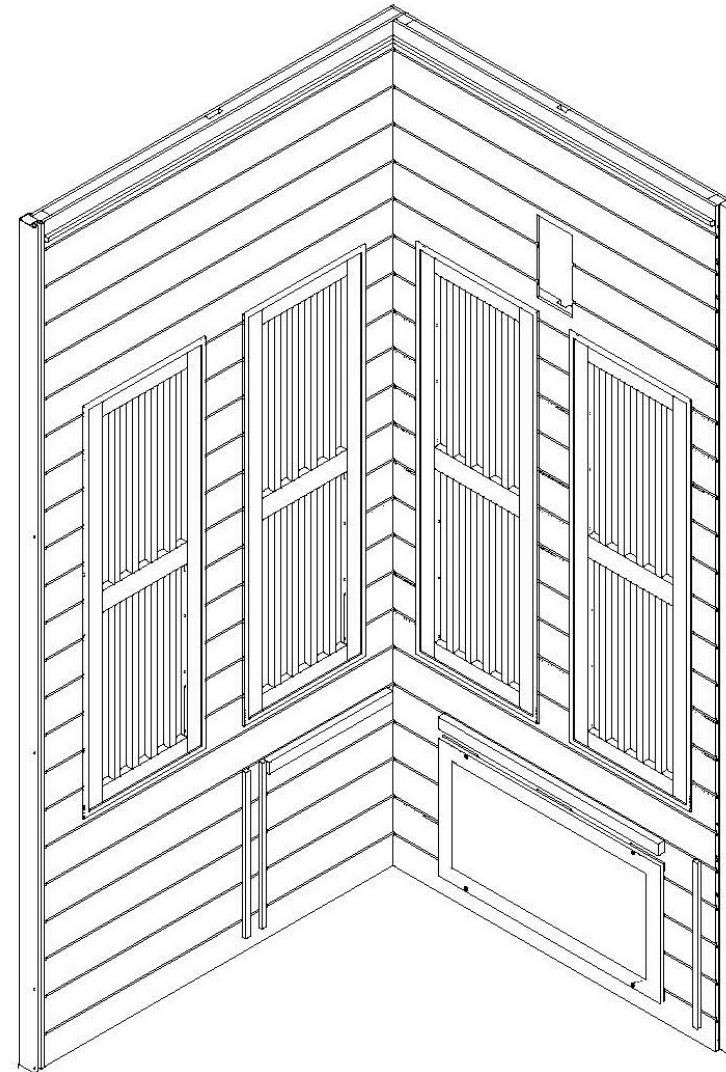

## Step 2 — Placing the floor into position

Locate the floor and place into position by pushing it up to the side and back panel tightly.

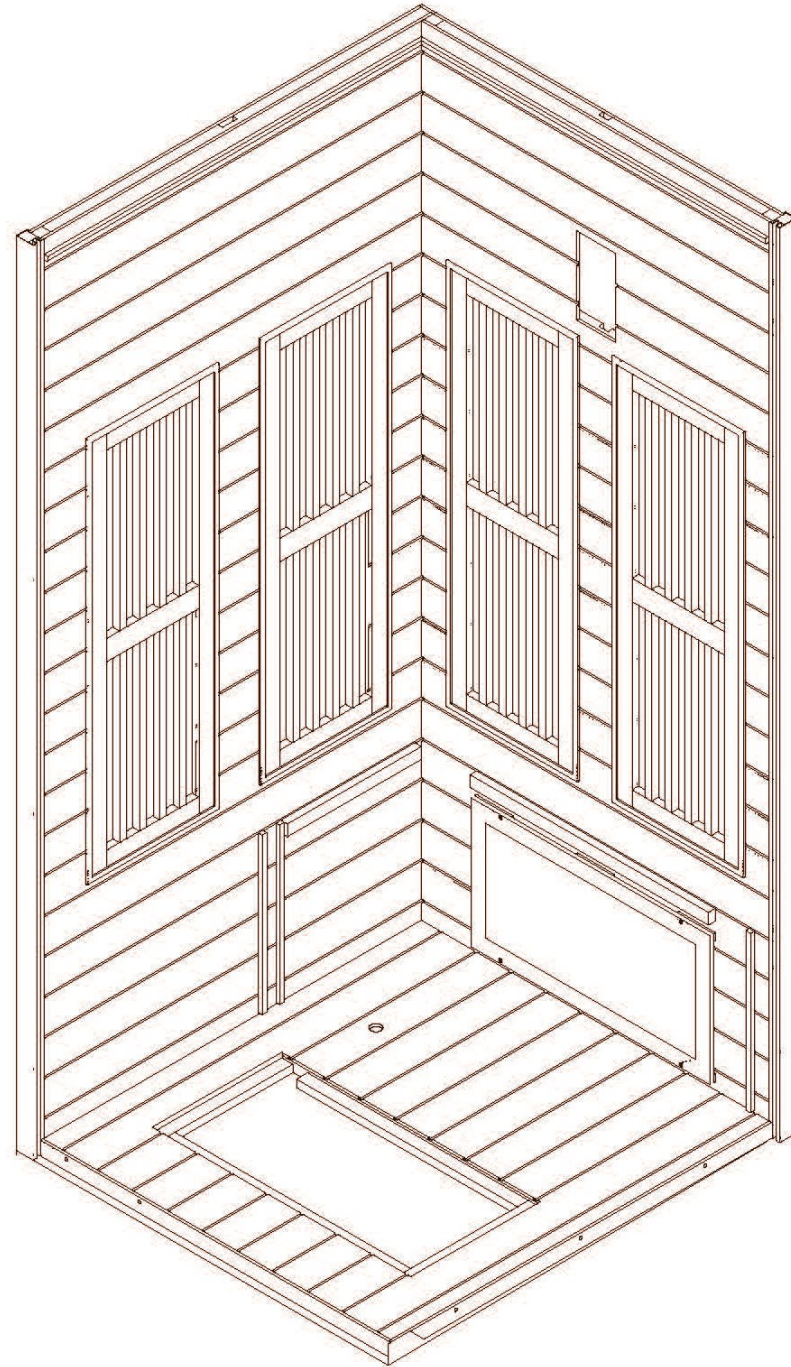



## Step 3 — Installing the bench

Locate the bench front and place between the two wooden struts on the side panel to secure it into position.

Locate the bench side and place between the wooden struts on the back panel to secure into position.

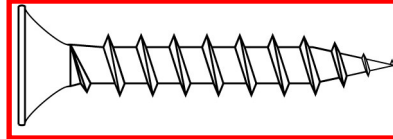

6 x 50mm Screws

On the inner side of the bench, locate the 50mm screws and secure the bench pieces to the floor, panels and each other.

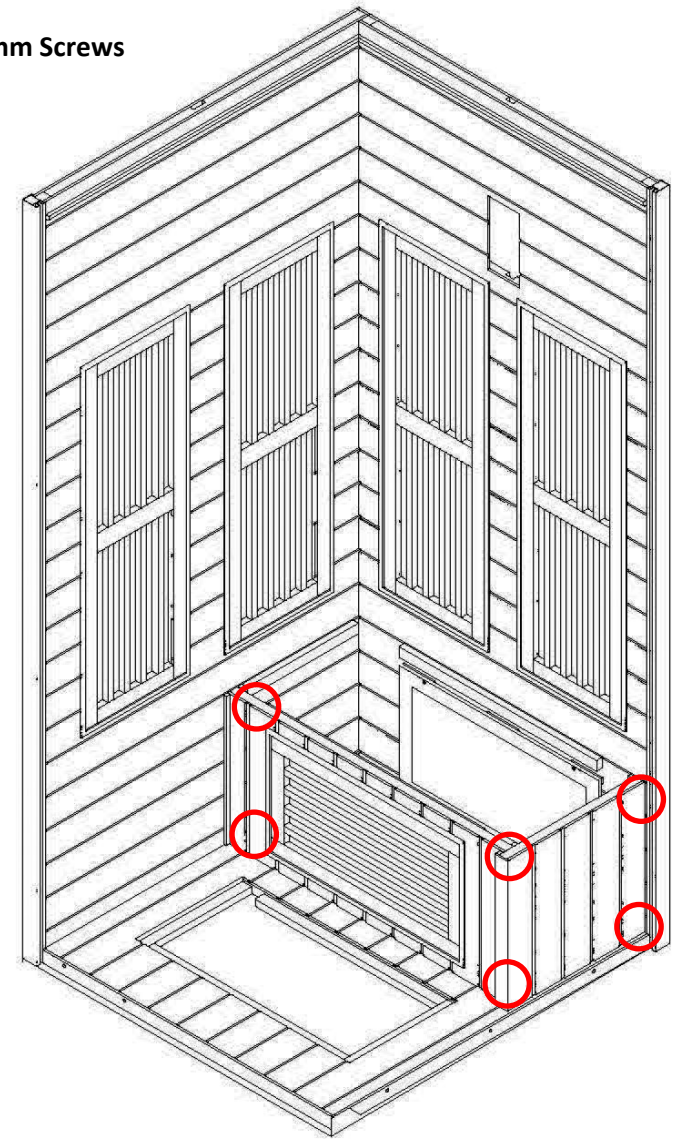
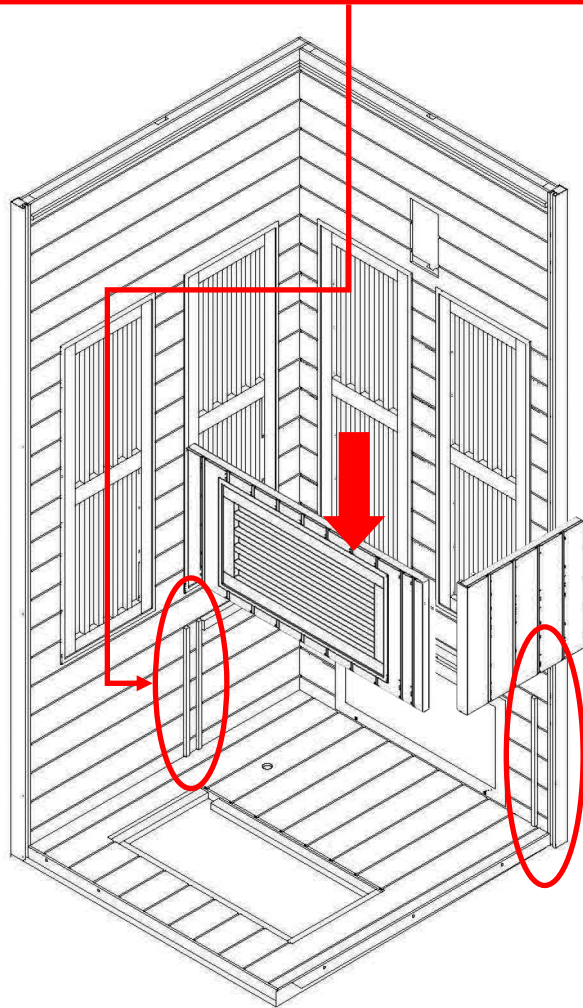



## Step 4 — Connecting the heater electrics

Locate the wires and connect together before finishing the bench install.

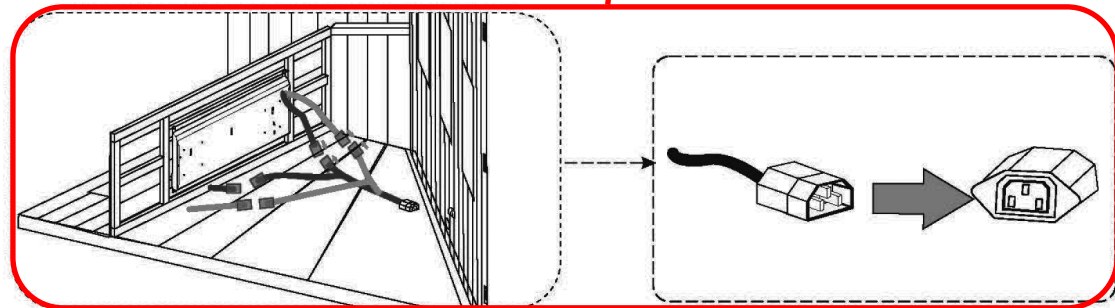
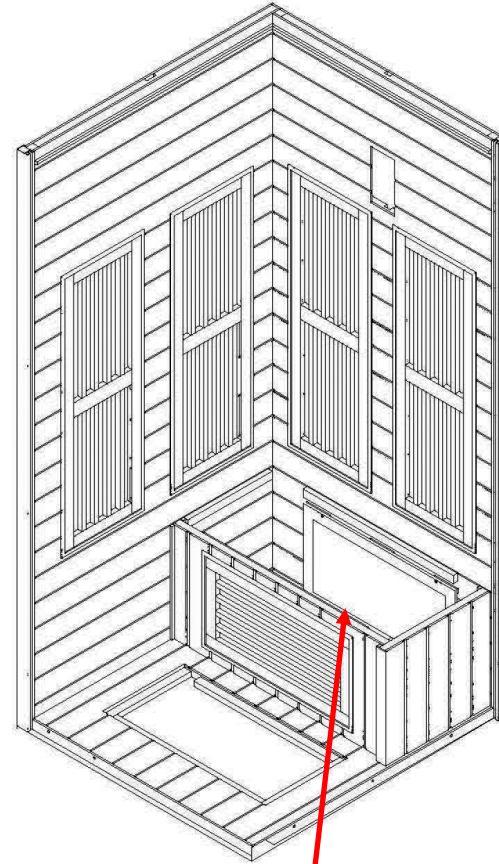

## Step 5 — Installing the bench topper

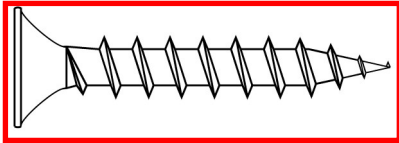

2 x 60mm Screws

Locate the bench seat and slide into position. The underside of the bench top will have a grooved recess which fits over the bench uprights.

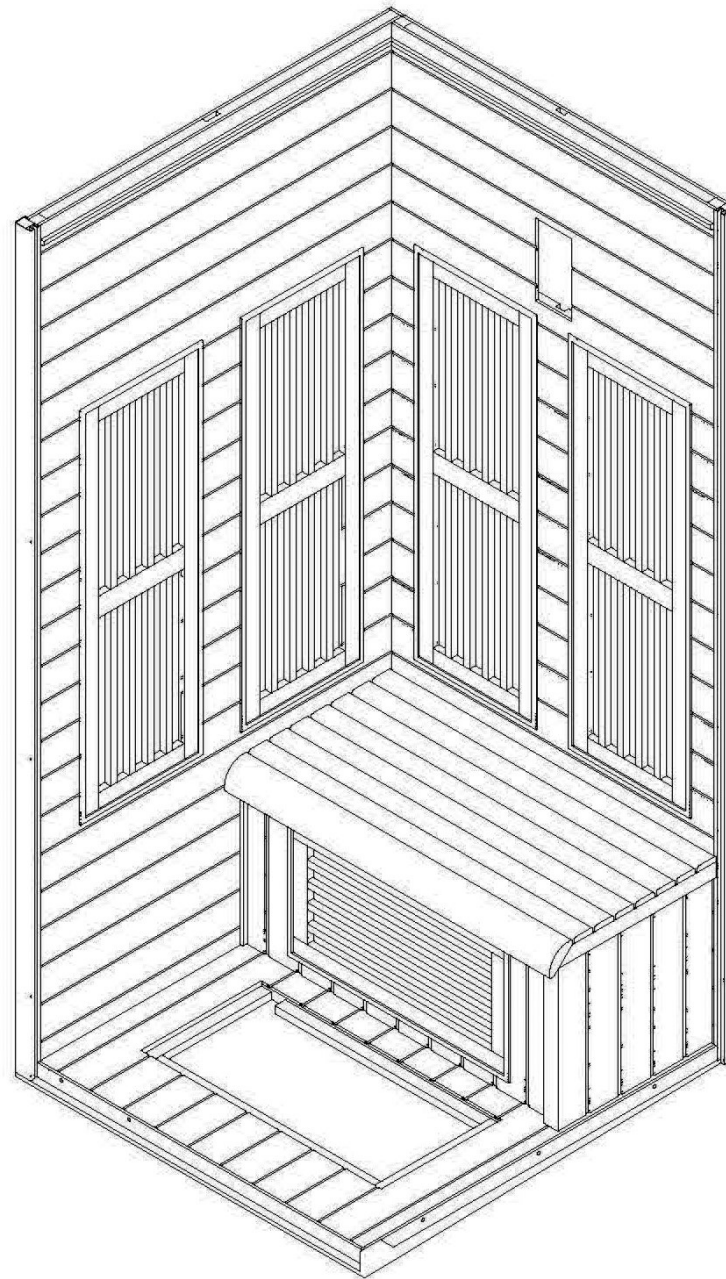

## Step 6 — Installing the central glass partition

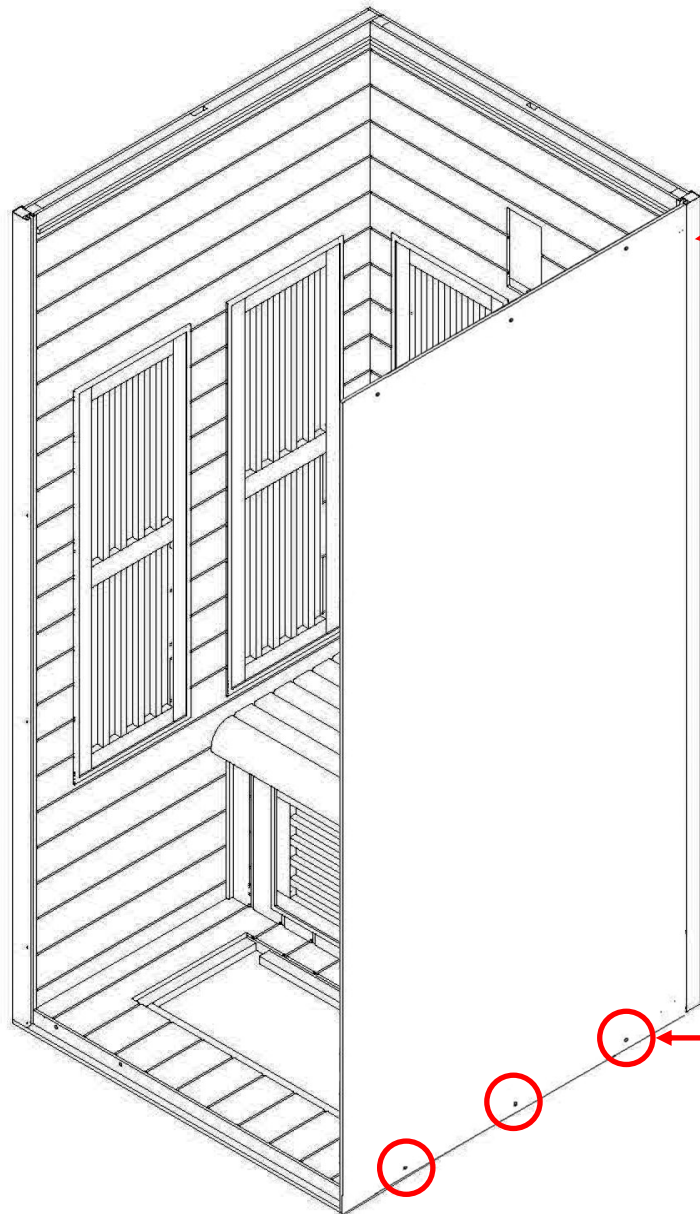

Locate the central glass partition panel and slide it into the connecting upright on the back panel.

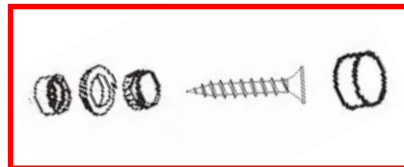

Secure in position by using the screw and spacer combo provided. Place the plastic glass spacer through the glass, then the washer and countersunk plastic head. Place the screw through all three and screw to secure, then place the chrome finishing cap in position.

## Step 7 — Installing the front fixed glass panel

Locate the front fixed glass panel and slide it into the connecting upright on the left side panel.

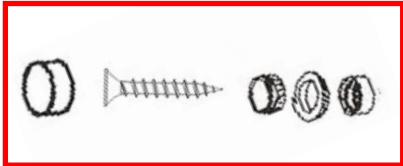

Secure in position by using the screw and spacer combo provided. Place the plastic glass spacer through the glass, then the washer and countersunk plastic head. Place the screw through all three and screw to secure, then place the chrome finishing cap in position.

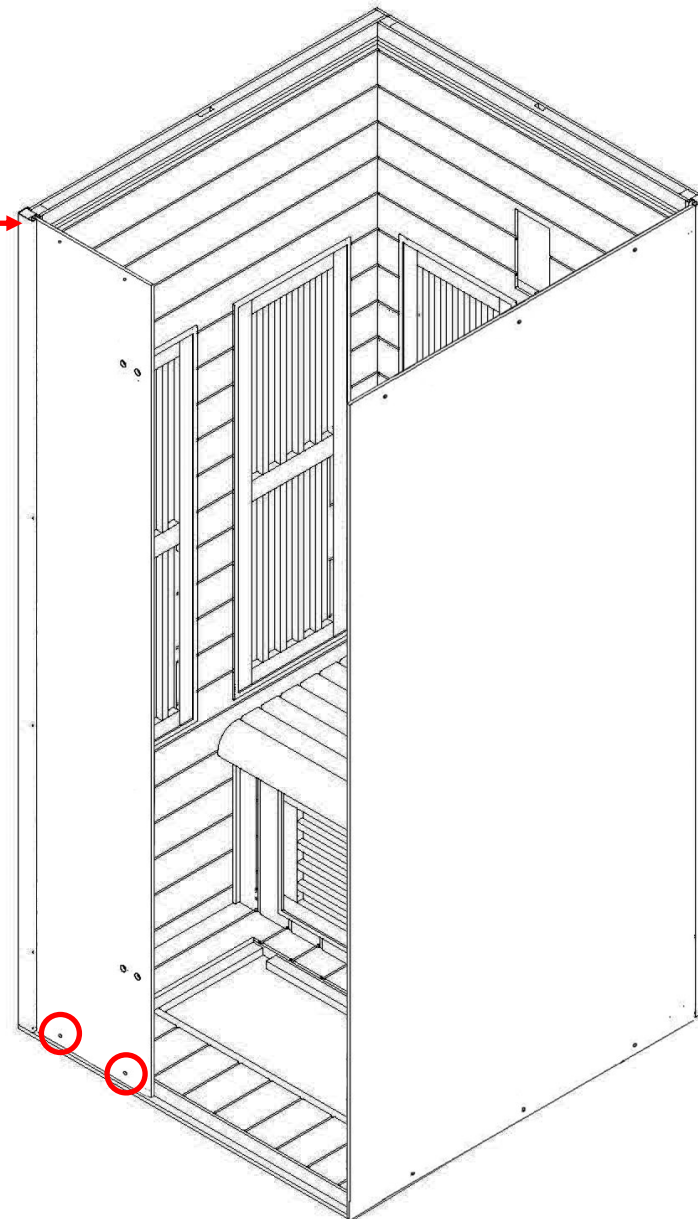

## Step 8 — Installing the Roof

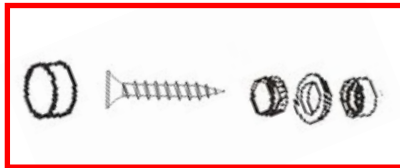

Locate the roof and place in position, then secure by using the screw and spacer combo provided.

Place the plastic glass spacer through the glass, then the washer and countersunk plastic head. Place the screw through all three and screw to secure, then place the chrome finishing cap in position.

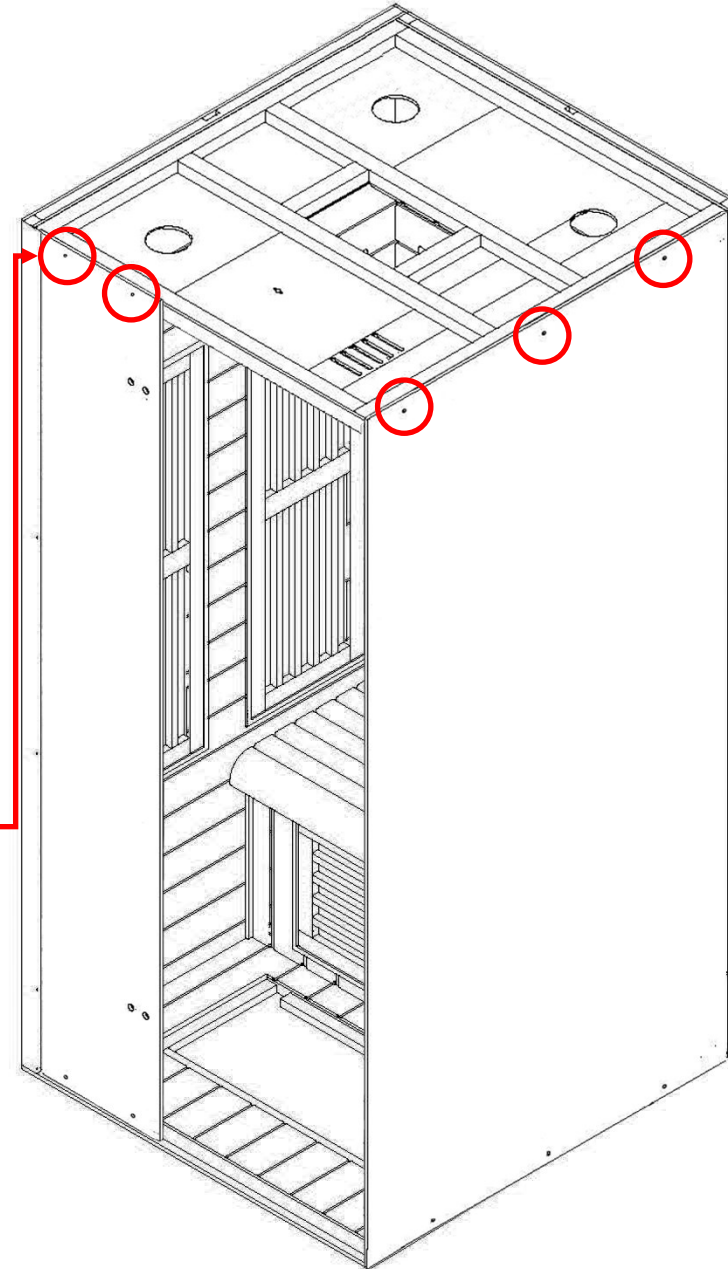



## Step 9 — Installing the Sauna/Shower front connection upright

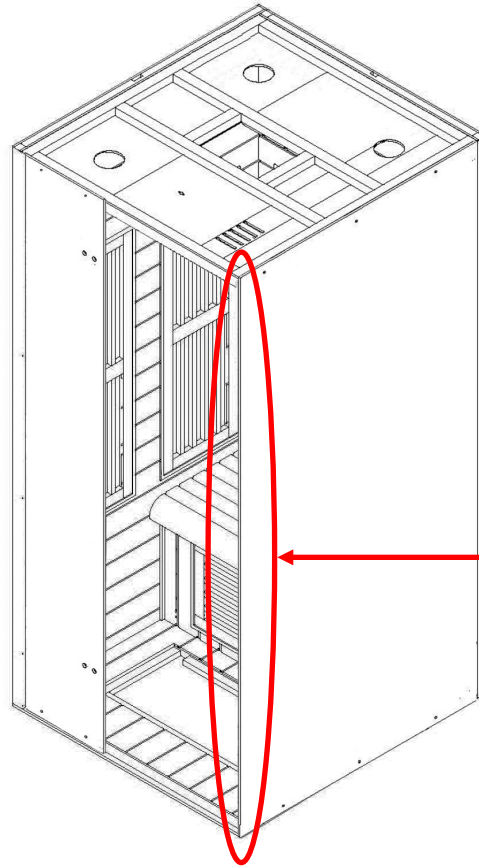

Locate the metal connection upright and slot it onto the central glass partition panel. This will be a secure and tight fit. If it is too tight, slightly slacken off the roof connection to ease the upright into position.

Ensure you retighten the roof afterwards.

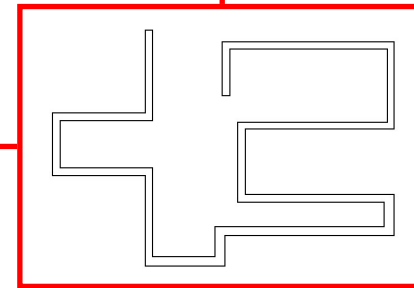

## Step 10 — Installing the Door

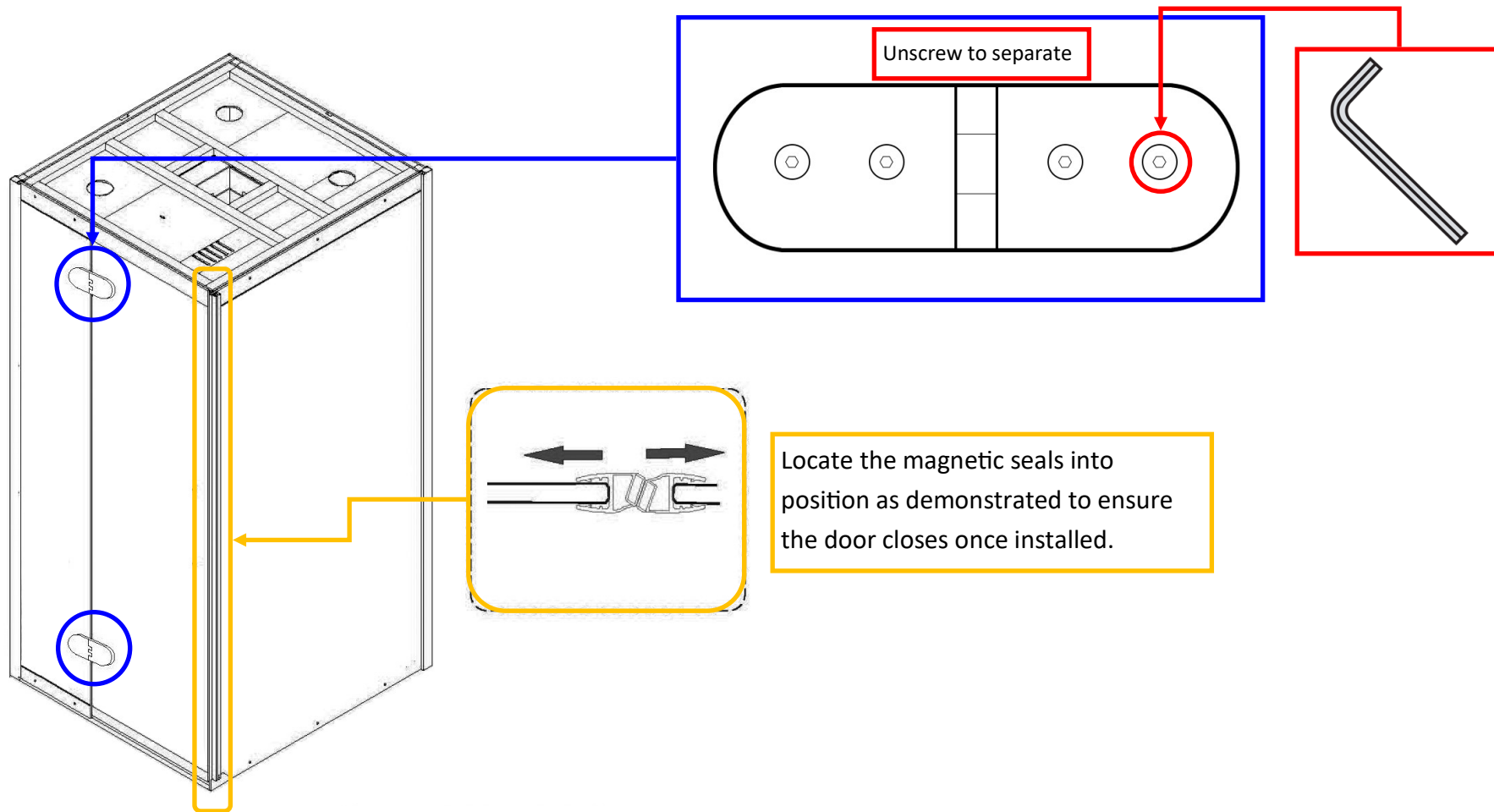

Attach the door hinge to the fixed glass panel before installing the door.

Lift the door into position and then fix the door into the hinges. To realign the door, loosen the bolts slightly, reposition and then retighten. Repeat this process until alignment is perfect.

## Step 11 — Door Handle Install

Separate the door handle using an Allen key and screwdriver. Once separated, align each handle and the connecting pieces on either side of the door and reconnect the handle.

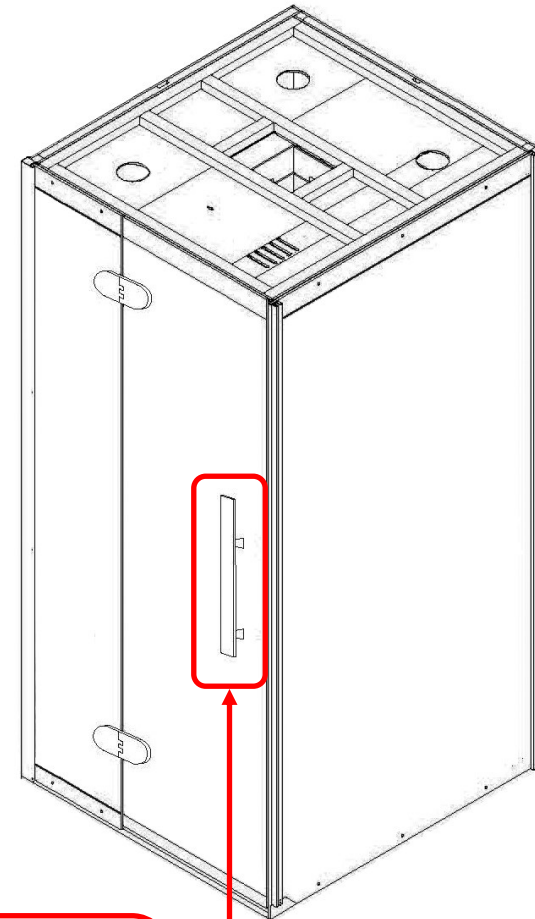
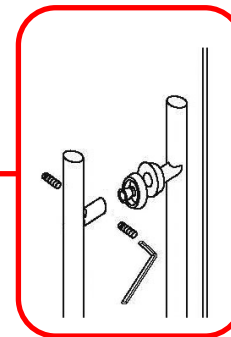
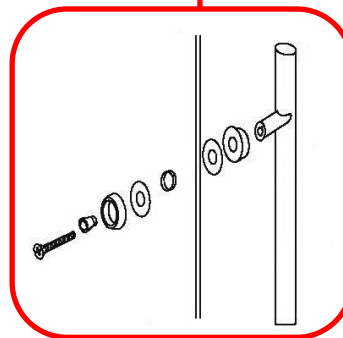
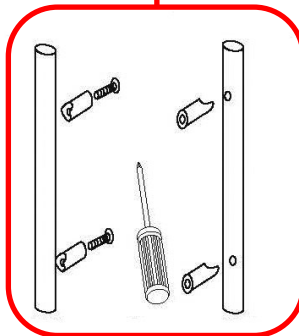
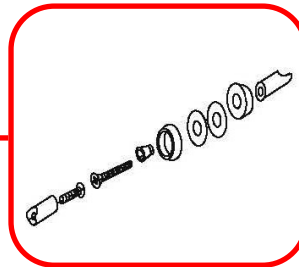

# Step 11 — Roof Cover/Electrics Install

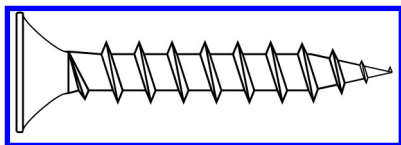

12 x 12mm Screws

Once the electrics have been installed, locate the roof topper and place in position and screw down using ST12 Screws.

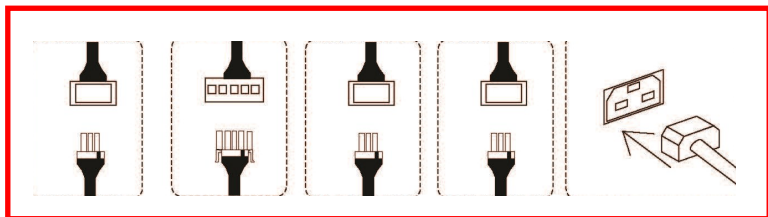
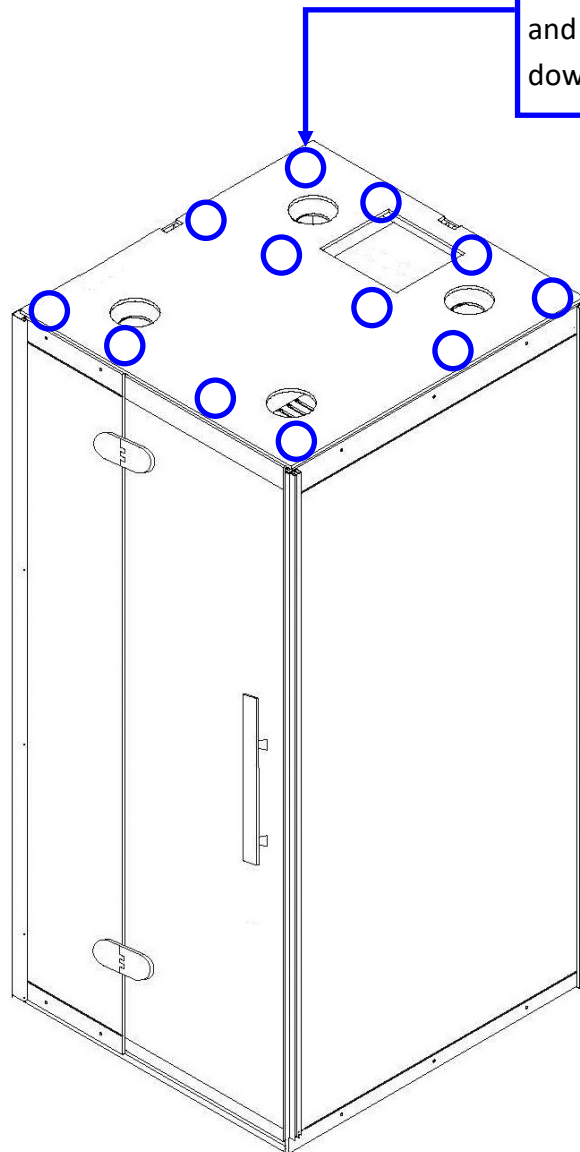

Locate all wires on top of the sauna and connect to the corresponding connection from the wires from the back and side panels. Use the cable tidies to secure wires neatly to the roof.

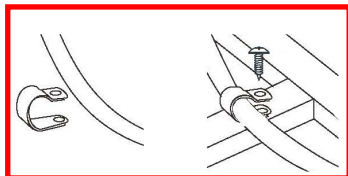

# Sauna Control Panel Instructions

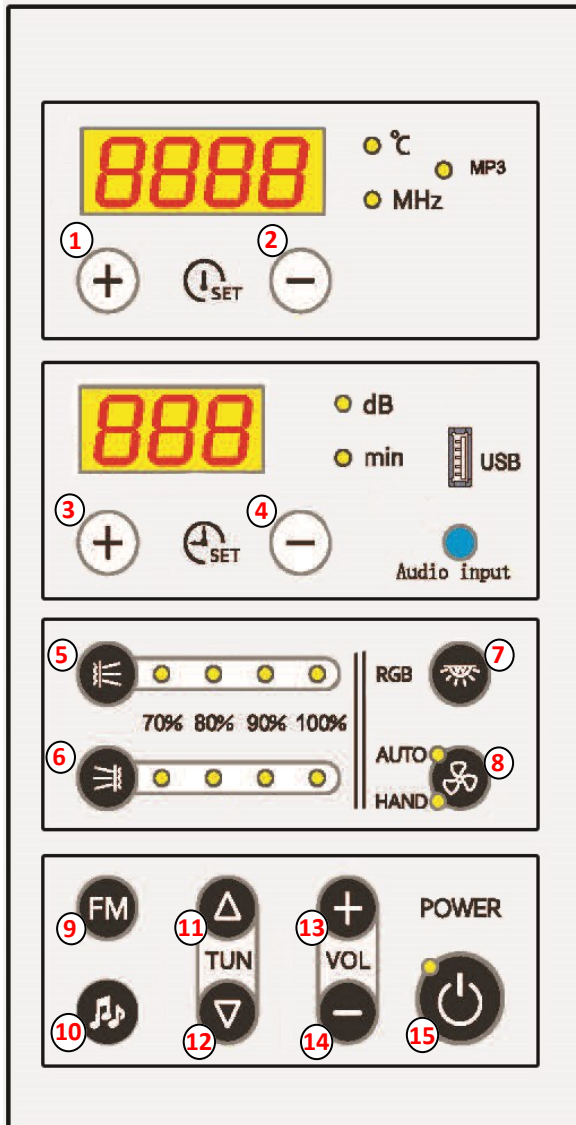

## Button 1/2 (+/- Temp)

Cycle through desired temperature setting (max 60°C)

## Button 3/4 (+/- Time)

Cycle through desired time setting (max 99 mins)

## Button 5/6 (Sauna Heaters)

Press to activate Sauna heaters. Pressing once will put the heaters on at 100%. Twice = 90%. Three times = 80%. Four times = 70% and five times = Off.

## Button 7 (Lights)

Press to cycle through the coloured lights. Each press will change colour until a full cycle is completed and they turn off.

## Button 8 (Fan)

Press to turn the fan on, press again to turn it to auto and then a third time to turn it off.

## Button 9 (FM)

Press to turn on the radio. Press and hold to auto tune the radio stations. To change radio station press tune.

## Button 10 (Audio Function)

Cycle through the audio function settings, MP3, USB, Bluetooth or AUX. When playing music through Bluetooth or USB simply use Tune (Button 11/12) to change track.

## Button 11/12 (Tune)

Press and use the +/- to manually search. Hold the buttons down for two seconds to speed scroll.

## Button 13/14 (Volume)

Press to cycle through the volume either up or down.

## Button 15 (Power)

Use to power the control panel on or off.



## Sauna Usage & Safety Guide

1. Never leave children unattended in the Sauna.
2. Regulate (if preferred) the temperature of sauna or steam before session - Pre-heat time 15-30 minutes (from room temperature 20c)
3. Never touch the heater panels whilst in operation, possible burning may occur.
4. Recommended time of use is a maximum of 15 mins initially. We highly recommend working up in time to this, beginning with 5 minute sessions to get your body used to using a sauna.
5. Suggested operational heat range: Infrared—30° C-40° C. Infrared optimum use range 35°C to 40°C
6. Stay hydrated during each sauna session.
7. Exit the sauna immediately if feeling dizzy, faint or short of breath.
8. Do NOT use the sauna function if you're pregnant, have a heart condition, have low or high blood pressure. If you're unsure consult your GP before use.
9. If you have any underlying health conditions which you feel could be aggravated by an increase in temperature, consult your GP before use.
10. If you begin to have any issues with your health after using a sauna, stop immediately and consult your GP regarding your symptoms before continuing to use.
11. Consult your GP before using the steam room if you're on medication at all, especially with drowsy side effects.
12. Never use the sauna if you have been drinking alcohol or under the influence of other substances.
13. Do not put combustible material on the heaters at any time.
14. Always turn power supply off after use.

## WEEE Compliance Statement

The UK Waste Electrical and Electronic Equipment (WEEE) regulations came into force on 2 January 2007. Under this new legislation, producers of electrical and electronic equipment (EEE) have to fulfil certain obligations.

Under the WEEE directive Insignia is considered the producer of certain products we supply and in line with the demands of the legislation we are pleased to offer the opportunity to return these products to us for treatment and recycling.

Insignia products will generally have an identifying mark and the common crossed out wheelie bin label. We accept returns of all products carrying the Insignia brand. All other products are either considered outside the scope of WEEE or Insignia is not technically the producer of these products. Insignia also accepts historic like-for-like WEEE returns. All WEEE returned to Insignia will be recycled in appropriate treatment and recycling centres in accordance with the legislation. If you wish to return any products to us, please send your item(s) to our head office.

Company Contract No. 326457

WEEE Producer No. CBDU64227

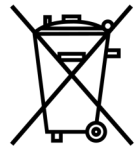

### LABELLING

Products labelled with the WEEE symbol (a crossed out “waste bin”) indicate that the final user should not discard this product along with other household waste, but that it must be collected and treated separately.



### Returns Address for WEEE

Insignia

9a Deans Road, Old Wolverton, Canon Industrial Park, Milton Keynes, Buckinghamshire, MK12 5NA, UK



### EU – Declaration of Performance

Insignia declares that all its products complies with the essential requirements and other relevant provisions of Directive 305/2011/EC. A copy of the Declaration of performance is available from [www.insigniashowers.com/ce-certification](http://www.insigniashowers.com/ce-certification)

Insignia™ is a registered trademark of Maclean International Ltd, 9a Deans Road, Old Wolverton, Canon Industrial Park, Milton Keynes, Buckinghamshire, MK12 5NA, UK

All images are subject to copyright. Images may not be used in any way shape or form with out written permission from Maclean International Ltd. Images are NOT permitted to be saved, printed or uploaded. Violation of copyright laws are punishable by law.

All images are registered with  
ImageTraker

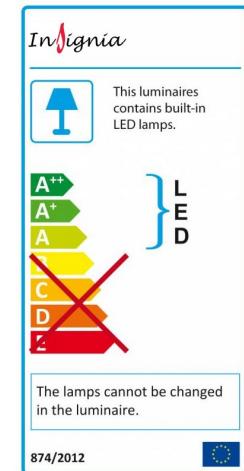

Insignia™ is a registered trademark of Maclean International Ltd

All images are subject to copyright. Images may not be used in any way shape or form with out written permission from Maclean International Ltd. Images are NOT permitted to be saved, printed or uploaded. Violation of copyright laws are punishable by law.